

2015

Methods for Determining Grease Service Levels in an AH-64D Intermediate Gearbox Using On-Board Sensors

Travis Steven Edwards
University of South Carolina - Columbia

Follow this and additional works at: <https://scholarcommons.sc.edu/etd>



Part of the [Mechanical Engineering Commons](#)

Recommended Citation

Edwards, T. S.(2015). *Methods for Determining Grease Service Levels in an AH-64D Intermediate Gearbox Using On-Board Sensors*. (Master's thesis). Retrieved from <https://scholarcommons.sc.edu/etd/3094>

This Open Access Thesis is brought to you by Scholar Commons. It has been accepted for inclusion in Theses and Dissertations by an authorized administrator of Scholar Commons. For more information, please contact digres@mailbox.sc.edu.

**METHODS FOR DETERMINING GREASE SERVICE LEVELS IN AN AH-64D
INTERMEDIATE GEARBOX USING ON-BOARD SENSORS**

by

Travis Steven Edwards

Bachelor of Science
University of South Carolina, 2012

Submitted in Partial Fulfillment of the Requirements

For the Degree of Master of Science in

Mechanical Engineering

College of Engineering and Computing

University of South Carolina

2015

Accepted by:

Abdel Bayoumi, Director of Thesis

Joshua Tarbutton, Reader

Lacy Ford, Vice Provost and Dean of Graduate Studies

© Copyright by Travis Steven Edwards, 2015
All Rights Reserved.

ACKNOWLEDGEMENTS

I would first like to thank Dr. Abdel Bayoumi for allowing me the opportunity to be a part of the CBM team and giving me the support to pursue this degree. Of course I would not be to this point in my life if it were not for the continued support from my friends and family, especially my parents, Roger and Laura Edwards. I am also very grateful to have such an excellent team of operators and support staff who are involved with CBM that made being a part of this program so rewarding, especially Erin Ballentine and Thomas Hartmann. I would also like to thank Andrew Patterson for reviewing my thesis multiple times and always making himself available to provide valuable recommendation.

ABSTRACT

The intermediate gearbox (IGB) on the AH-64D was chosen as the subject for this study based on the persistent grease leaks that require grounding aircraft. The aircraft is not currently equipped with a method of detecting grease loss during flight, so techniques for analyzing the usefulness of old metrics and possible new techniques can be tested. The main objective of this study is to use the aircraft's on-board sensors to develop a method of determining the lubrication level of the IGB. Currently, the most reliable method for detecting a fault on the aircraft is through the use of vibration-based condition indicators (CIs). The results of this research show a negative correlation between vibration and grease service levels when analyzing specific CIs for the IGB on the AH-64, which can be basis for automated leak detection.

Another objective of this study is to quantify the standard operational grease level for IGBs in the AH-64 fleet. This standard would be created by measuring the amount of grease left in each gearbox after burping. This grease level would then be used to insure that if lubricant was leaking out of the component, it is due to a fault instead of an overfilled article. If the level is the same for each gearbox then a new standard can be implemented to prevent burping. By being able to use an installed on-board sensor to indicate the level of grease in the gearbox this would relieve the burden of the maintainer from having to check the level every 25 flight hours. The soldier would then be able to spend his time in another area that is more critical than a routine maintenance item.

For this analysis three gearboxes of similar condition were used. Each one was run for two hours at five different grease service levels of 0%, 25%, 50%, 75%, and 100%, based on the Army Depot standard amount of 964 grams. These gearboxes were tested on the USC tail rotor drivetrain (TRDT) test stand according to a test plan defining operational conditions. The test plan specifies torque and speed values that are similar to those experienced by the component during flight. The existing on-board modernized signal processing unit (MSPU) CIs, the raw time-domain data, and temperature data were collected and analyzed to try and identify a CI to indicate grease level.

By using statistical analysis tools and some known fault cases, CIs can give the user a different view into the operation of the gearbox as opposed to standard vibration analysis. This happens to hold true for this experiment, in which investigation of the two CIs, output bearing energy and input bearing energy, revealed an inverse correlation between grease level and vibration magnitude. Out of the two algorithms mentioned, the input bearing energy had the strongest correlation, making it the best candidate for monitoring grease level through vibration in the field. The raw vibration data collected, unlike the conditioned MSPU, data was too noisy and did not yield any valuable results. It was also noted that gearbox temperature increased as the grease service level increased; this was unexpected because it was believed that the greater the service level of the component, the lower the operating temperature would be. This trend was more stable and consistent from gearbox to gearbox than the one seen using the vibration data. These results prove that it is possible to monitor the quantity of grease in the gearbox through on-board sensors, and also serve as a testament to the usefulness of putting condition-based maintenance techniques into practice in the field.

TABLE OF CONTENTS

Acknowledgements.....	iii
Abstract.....	iv
List of Tables	ix
List of Figures.....	x
List of Symbol.....	xii
List of Abbreviations	xiv
CHAPTER 1: Introduction	1
1.1 Background	1
1.2 Literature Review.....	2
1.3 Problem Definition.....	5
1.4 Solution Proposal	5
1.5 Overview	7
CHAPTER 2: Condition Monitoring Theory and Techniques	9
2.1 Run-to-failure Management.....	9
2.2 Time-Based Maintenance.....	9
2.3 Condition-Based Maintenance (CBM).....	10

2.4	Testing.....	11
2.5	IGB Overview	12
2.6	Sensors	13
2.7	Digital Signal Acquisition.....	14
2.8	Temperature Analysis	14
2.9	Vibration Analysis.....	15
2.10	Time-Domain Analysis	16
2.11	Frequency-Domain Analysis.....	18
CHAPTER 3: Experimental Program and Test Facility		22
3.1	IGB.....	23
3.2	Instrumentation and Data Acquisition System.....	24
CHAPTER 4: Experimental Procedures		28
4.1	Gearbox Changeout.....	28
4.2	Pre-run Procedures	29
4.3	Running Procedures	30
CHAPTER 5: Experimental results and discussion of current condition indicators		32
5.1	Raw Vibration Results	33
5.2	MSPU CI Results	36
5.3	Temperature Results.....	42
5.4	Sensor Fusion Results	47

5.5 Grease Ejection Results.....	48
CHAPTER 6: Conclusion.....	51
References.....	54
Appendix A – Pre-Run Inspection.....	58
Appendix B – Expanded Raw Vibration Results.....	60

LIST OF TABLES

Table 4.1. List of Tests	28
Table 4.2. Modified TRDT Load Profile	31

LIST OF FIGURES

Figure 1.1 Tail Rotor Gearbox Vertical Bearing Energy measured over time	6
Figure 2.1 Diagram of Intermediate Gearbox [7]	12
Figure 2.2 Sweep test results for virgin grease and an IGB and TGB grease sample	13
Figure 2.3.A flowchart of signal processing analysis [14]	16
Figure 2.4 Flow chart of transforming raw vibration into a CI value [15]	21
Figure 3.1 Comparison between the aircraft and USC test stand	22
Figure 3.2 Internal view of the IGB [7]	24
Figure 3.3 Model of MSPU	25
Figure 3.4 Sensor layout of the IGB	27
Figure 4.1 A comparison, from a previous experiment, of worn gear teeth (left) to healthy teeth (right).....	29
Figure 4.2 Breather port adapter setup.....	30
Figure 5.1 List of IGB condition indicators monitored by the MSPU.....	32
Figure 5.2 An example of a FFT made from vibration data	33
Figure 5.3 Gearbox #1 vibration results	34

Figure 5.4 Gearbox #3 vibration results	35
Figure 5.5 Graph displaying two CI values for gearbox #1, Output Bearing Energy(Left) and Input Bearing Energy(Right).....	37
Figure 5.6 Graph displaying two CI values for gearbox #2, Output Bearing Energy(Left) and Input Bearing Energy(Right).....	38
Figure 5.7 Graph displaying two CI values for gearbox #3, Output Bearing Energy(Left) and Input Bearing Energy(Right).....	39
Figure 5.8 Graph displaying normalized Output Bearing Energy CI results across gearboxes	40
Figure 5.9 Graph displaying normalized Input Bearing Energy CI results across gearboxes	41
Figure 5.10 Temperature of gearbox #1 at various grease levels	43
Figure 5.11 Temperature of gearbox #2 at various grease levels	44
Figure 5.12 Temperature of gearbox #3 at various grease levels	45
Figure 5.13 Temperature correlation to grease lubrication level	46
Figure 5.14 Estimated grease level based on the sensor fusion equation created.....	48
Figure 5.15 Grease ejection for different gear boxes.....	49

LIST OF SYMBOLS

RMS	is the root mean square value of dataset $x(n)$
x_n	is a data series of length N
N	is the number of points in dataset $x(n)$
$G(f)$	is the representation of $g(t)$ in the frequency domain
$g(t)$	is any arbitrary signal in the time domain
x_n	is a data series of length N
K	is the Kurtosis of the signal x of length N
x_i	is the amplitude of the signal of the i -th sample
\bar{x}	is the arithmetic mean of the signal x
d_i	is the amplitude of the i -th point of the difference signal
\bar{d}	is the arithmetic mean of the difference signal d
N	is the length of the difference signal
EL	is the estimated grease level
A	is constant of value 0.007906

B is constant of value -0.0115

C is constant of value -0.008396

LIST OF ABBREVIATIONS

AED	Aviation Engineering Directorate
AH.....	Attack Helicopter
CBM.....	Condition-Based Maintenance
CI.....	Condition Indicator
DAQ.....	Data Acquisition
FM4.....	Fourth Order Figure of Merit
FPG	Flat Pitch Ground
GBS.....	Ground Based Station
HUMS.....	Health Usage Monitoring System
IGB.....	Intermediate Gearbox
MSPU.....	Modernized Signal Processing Unit
SCARNG	South Carolina Army National Guard
TGB.....	Tail Rotor Gearbox
TRDT	Tail Rotor Drivetrain

TRSP.....Tail Rotor Swashplate

USC..... University of South Carolina

VI Virtual Instrument

CHAPTER 1: INTRODUCTION

1.1 Background

Historically, it has been observed that some of the most common maintenance faults for the attack helicopter (AH)-64D gearboxes are related to leaking or ejected grease. Some of these issues present only an inconvenience to maintenance crews, while others require extensive maintenance procedures or part removals [1]. Though the maintenance actions are relatively minor, the frequency of the fault causes the cost to add up over time. The intermediate gearbox (IGB), which changes the angle of the drive train and has been chosen as the subject of this study due its propensity to leak grease

Condition monitoring technologies that determine the health of a machine are crucial for implementing novel maintenance practices; this set of ideas is called Condition-Based Maintenance (CBM). Industry standards for CBM focus mainly on vibration analysis, with some input from temperature signatures [4]. Vibration has proven itself to be a better indicator of failure because it displays a slow trend over time whereas temperature change is much more sudden and tends to occur near the very end of a component's life. Therefore vibration is considered a more promising candidate for advancing CBM techniques.

1.2 Literature Review

In the past, researchers have mostly focused their efforts on mechanical faults of machine components with sensors through condition-based maintenance, but seldom look at how to determine lubrication level in bearings and gearboxes. A few engineers have shown interest in gearbox element lubrication level and have conducted several studies in the past using different CBM techniques.

Lee et al. was able to accurately predict gearbox lubrication in wind turbine planetary gears by using partial swarm optimization and weighted k-nearest neighbor algorithms on vibration data with an average confidence level of 87%.

The experiment ran 100 lubrication samples in a 10:1 planetary gearbox at 11 different levels. Each test was run at 4,000 rpm with various loading on a test bed that consisted of a motor and generator. The data was later divided into 990 training samples and 110 test data sets and analyzed using KNN. Both the current and vibration signals were studied from the gearbox

The study needs to be further analyzed because only one gearbox was used and the findings focused heavily on a current signal, which cannot be collected for the AH-64D using on-board sensors for the IGB. The gearbox was also not exposed to the same loading conditions as an AH-64 and contained planetary gears instead of duplex gears. The group also neglected to analyze temperature as a possible source of grease level indication.

Parikka et al. found that in roller element bearings the most sensitive frequencies at which to detect vibration acceleration RMS value are at 8-12 kHz, and that the natural

frequencies were the most sensitive to lubrication changes. He also found temperature to be strong indicator of lubrication level because operating conditions decreased by 50°F throughout the experiment. He believed this correlation may possibly be used in the determination of optimal re-greasing interval and quantity.

His group used a bearing test stand that was run for approximately 225 hours with 15kN of load applied at a speed between 0 and 2,500 rpm. Temperature, vibration, and acoustic emission were monitored continuously throughout the experiment. The bearing was tested until regreasing was necessary and then continued to run. The experiment was completed three different times with comparable results from each series.

This failed to analyze other rotating machinery and only studied a bearing, not looking at the regreasing of gearboxes. The study was also completed at a speed and torque that was much lower than the standard operating rpm for the AH-64. The data was also processed using a small amount of condition indicators. This study was more of a proof of concept because no prediction or statistical analysis was conducted.

Niknam et al. used acoustic emission to try and identify when rotating component was dry or lubricated. He successfully completed this study, but only on components that were running between 60-100 Hz.

Eight rotational speeds (30-100 Hz) and four levels of radial load were applied to various dry and lubricated bearings. The acoustic emissions data was recorded throughout all of the runs and analyzed.

An acoustic emission recorder is not a common sensor on the aircraft and to monitor grease level it would have to be added on, which would increase the aircraft

weight. The work was only presented as a proof of concept because there was no analysis done to prove how much grease had been lost from the rotating component. In order to implement this in the field and be able to service properly a correct amount of grease would need to be applied to the gearbox to avoid over servicing.

Nooli et al. did work to prove that the simultaneous mechanical and thermal effects of the gearbox cause it to lose viscosity, which leads to the loss of grease in the aircraft gearbox. He showed that current condition indicators on the aircraft were not viable for TGB grease leakage detection. His work called for further explanation into the cause of this grease property change and how it affects the overall life of the IGB.

His team tested three different tail rotor gearboxes that were lubricated a specified amount and gradually drained as the test progressed, all of the grease ejected after 150 hours of testing. The purpose of this work was to try and detect faults due to tooth wear of a component. Each of these articles were test under normal flight loading conditions and were run for an average of 500 hours, some ran longer than others.

This work did not look at temperature in-depth as a source for grease detection. Also there was no conclusion as to a possible earlier indicator for grease leakage on the gearbox. There have been further advances in the condition indicators on the gearbox since this work was published, which could be analyzed further and possibly hold the answer to an early leak detection algorithm.

His work called for further explanation into the cause of this grease property change and how it affects the overall life of the IGB. These studies show the feasibility

of using software and sensors native to the aircraft to determine the grease lubrication level in the IGB on the AH-64 [14, 20, 21, 29].

1.3 Problem Definition

To detect physical changes in the helicopter components, condition indicators (CIs) are calculated using various algorithms. However, there are limitations on the extent at which CIs can detect problems since each of these algorithms is not targeted to every specific type of fault. Presently, there is no CI value to tell the maintainer the lubrication level, so it must be checked every 25 flight hours by a maintainer using a special tool designed for checking both the tail rotor and intermediate gearboxes.

This problem introduces the two objectives of this work: One is to create a safer, more reliable helicopter by establishing a CI that can detect grease loss and allow the maintainer to properly service the gearbox without the need to add any additional sensors to an aircraft. The second is to accurately quantify the amount of grease that the gearbox is serviced with to help prevent the further unnecessary loss of lubrication from the IGB. If an indicator can be created from this CI, which warns when the grease level has dropped, then maintainers can skip level testing every 25 flight hours which will lead to time savings and cost avoidance.

1.4 Solution Proposal

Experimentation is required to determine if a correlation exists between the grease service level and the vibration magnitude of the IGB. If no correlation exists, current maintenance practices are confirmed and a grease level monitoring system via vibration cannot benefit the health of the helicopter.

One of the benefits of having components run on a test stand rather than on an aircraft is that experiments can be conducted safely and are more cost effective. The safety of the testing setup has allowed the University of South Carolina (USC) to conduct an experiment in which three tail rotor gearboxes (TGB) were run-to-failure, which averaged out to 500 hours each, with no grease in the component housing. During one of those runs, it was noticed that the vibration levels changed after being serviced with grease, leading to this investigation. The change due to grease addition appeared in the Tail Rotor Gearbox Vertical Bearing Energy CI (Figure 1.1). Grease was added on January 15th and a significant drop in vibration can be seen following that date (denoted by the red arrow).

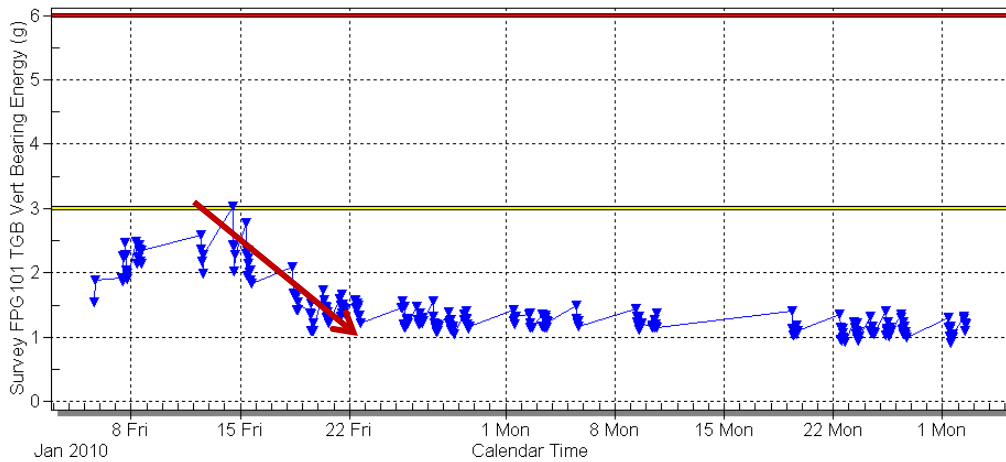

Figure 1.1 Tail Rotor Gearbox Vertical Bearing Energy measured over time

Though this change was noted, no further research was conducted and the correlation between grease level and vibration remained unconfirmed and uncharacterized. The expected outcome of further experimentation is that the grease level is a critical factor to the performance of the helicopter and that when the grease level decreases, the vibration will increase parametrically. By showing this correlation

using on-board CIs, maintenance practices can be changed from the current time-based scheduling to a condition-based procedure contingent on vibration levels in the gearbox. Furthermore, if the correlation is determined to be consistent between gearboxes, a standard minimum grease service level can be set.

1.5 Overview

This thesis is formatted into six chapters that go through the research experiment conducted; starting from the theory and practice and ending at the results and suggestions for future work. This chapter introduces the goals of the research, condition-based maintenance, define the project, and suggest a solution for how to solve the problem.

The second chapter presents the theory and background of the project by first introducing three different maintenance practices and the positive and negative ideas associated with machine maintenance. Then it transitions into how to properly test components and the specific options for sensors. Finally, digital source collection practices are covered and how to analyze the specific types of data that were acquired during this experiment.

The third chapter gives an overview of the experimental setup, including the test stand at USC, and then goes into detail about the sensor setup first through the different data acquisition systems used, and then the specifications of each type of sensors from which data is collected.

The fourth chapter covers the actual experiment conducted and the parameters in which it followed during testing. These include the change outs of the gearboxes and the precautions taken to yield the safest environment possible.

The fifth chapter is the results of the experiment mentioned above. These include the raw vibration data that came from the USC DAQ and a select few CIs from the health usage monitoring system (HUMS) box that is installed on most of the aircraft. Other results include operating temperature of the gearbox and grease ejection for the duration of the tests.

The sixth chapter concludes the work, explaining the benefits of the work and the future endeavors that can now be undertaken because of this experiment.

CHAPTER 2: CONDITION MONITORING THEORY AND TECHNIQUES

2.1 Run-to-failure Management

Run-to-failure is an idea that was institutionalized at the height of the Industrial Revolution. The objective is to maximize the productivity of each machine by running it until it stops working. This style of maintenance is the basis of the quote, “If it ain’t broke, don’t fix it.” While this style does get the most life out of each component, the downtime and financial burden placed on the company during the unforeseen maintenance outweighs the benefit of longer life.

2.2 Time-Based Maintenance

Time-based maintenance, also known as preventative maintenance, attempts to head off the problems caused by the run-to-failure method by scheduling service times. This method of servicing equipment is implemented according to standards set forth by the manufacturer so that certain actions will occur at specific intervals of run-time. A common example of this form of upkeep is oil changes being performed between every 3,000-7,500 miles on automobiles. This maintenance practice does allow for a smaller stock of parts and less standby equipment, but the constant maintenance being performed on the component makes it more vulnerable to failure. Time based maintenance does make the user aware of downtime, but it still does not maximize the life of the component, and does not account for sudden changes in the operating conditions [13].

2.3 Condition-Based Maintenance (CBM)

By utilizing condition-based maintenance, the operator can be warned when the component is about to fail through sensor-based analysis of the machine. Through data collected, such as vibration and temperature, the maintainer can be notified when the performance is degrading. If done correctly, a user can schedule maintenance closer to the time-of-failure and at a time that is convenient to the rest of the facility. Condition indicators (CI) are algorithms that are a more quantifiable way to describe the health of a component without having to wait until failure. Temperature and vibration are two reliable sources of data for CIs that may detect faults in a component that would not be noticed through normal operation inspections. Temperature also serves as a good condition indicator because a sudden rise indicates a component is near the end of its service life and needs to be taken offline immediately. This form of service does have a high initial start-up and requires frequent access to equipment [13]. CBM is the most preferred form of maintenance because it gives the user the ability to see how the machine is functioning and allows him to properly control downtime.

2.3.1 Smart Predictive Systems (SPS)

The SPS method is the future of machinery maintenance: it combines historical data, test stand data, and simulation data to create algorithms that can predict the amount of life left in a component based on the operating conditions. It takes data collected using condition-based maintenance a step further because it can accurately predict the run time of a particular component by fusing the three aforementioned data sources. In CBM, thresholds on a component can only be applied based on testing, but those thresholds are sometimes inaccurate due to limited amounts of data. Ideally a significant amount of

testing should be completed so that reliable CIs can be created. Being based on statistical information from failure history and test stand data, it yields the best results for predicting component failure based on average operating conditions [12]. The best model is one that combines physics based simulations and reliability information and will lead to steady improvement in prognostics maintenance in the future.

2.4 Testing

A test stand is used as a platform to get reliable data that would otherwise have to come from the field. Testing facilities can be equipped with single components or entire drive systems based on the need. This makes them a more cost effective option than running an entire machine just to test a single component. Furthermore, the environment can be controlled and faults can be introduced into the system where safety is not a significant risk; unlike if the same procedure were being performed in the field. When dealing with a system like an aircraft, it is much easier to perform a modification to a test stand than on an aircraft in the fleet. One of the goals of testing is to be able to accurately compare data between components run on a test stand to the data that would come off of an article being run in the field.

Although testing in a controlled environment may not exactly replicate every extreme situation seen by an aircraft it can still provide valuable information about the operating characteristics. Being able to have control over certain variables allows the test stand operator to create some conditions, like a misaligned driveshaft, that are more extreme than normal conditions. Testing allows for the upper limits of the flight envelope to be pushed and surpassed in a safe environment so that the limits of components can be verified in harsh conditions for extended periods of time.

2.5 IGB Overview

The purpose of the IGB on the AH-64D is to change the direction of the drive as well as output speed. The main components of the IGB are the input rolling bearing, input duplex bearing, output duplex bearing, and output roller bearing. The primary lubricant on the IGB is NS 4405-FG grease, which has lithium complex as thickener and is of NLGI grade 000 [21]. The AH-64 uses grease as a lubricant because of its high viscosity characteristics; this allows the lubrication of the gearboxes to continue to function if the component happened to be damaged.

A naturally occurring fault of the IGB is the ejection of grease from the breather port; even newly serviced AH-64D IGBs have been found to eject large volumes of grease. This fault could require the aircraft to land for immediate maintenance, which is the focus of this experiment (Figure 2.1).

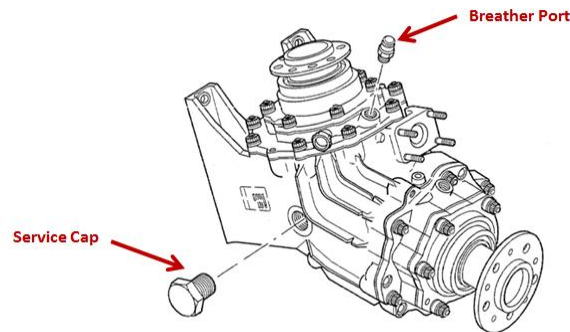

Figure 2.1 Diagram of Intermediate Gearbox [7]

A common belief is that the ejection occurs when the grease is exposed to in-flight operating conditions. The physical and rheological properties of the grease change after a certain period of time even when the temperatures are within operating limits [3]. One possible mechanism responsible for this phenomenon is the simultaneous application

of mechanical and thermal loads. Rheological characterization of the IGB grease samples revealed reduction in their apparent viscosities when compared to the virgin grease at shear rates tested (Figure 2.2).

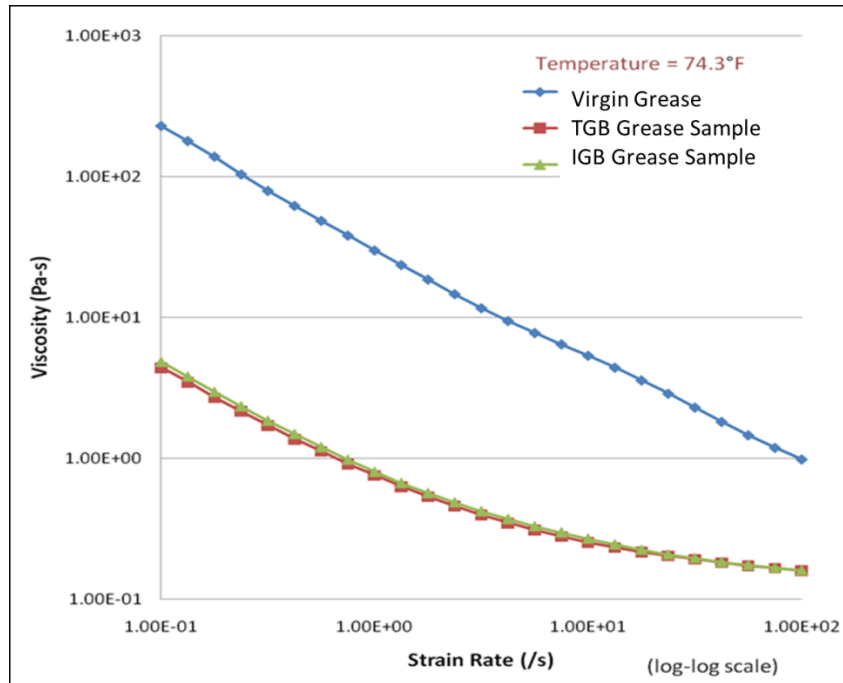

Figure 2.2 Sweep test results for virgin grease and an IGB and TGB grease sample

2.6 Sensors

Sensors commonly used in the CBM field collect vibration, temperature, acoustic, speed, and torque data. Vibration is normally collected through piezoelectric devices known as accelerometers, and is regarded as one of the most critical pieces of data collection for CBM. Although an increase or decrease in amplitude may indicate a change in the system, this is not always true; therefore, every change in vibration source should be well characterized [13]. The system's speed is measured with a magnetic tachometer. This tachometer is normally used to verify that the system running is at the

correct speed and also plays a vital role in calculating some CIs which require knowledge of the exact speed of rotation. Along with speed, torque is also measured using the USC DAQ. This ensures that nothing critical is being altered by a component on the drivetrain that would stop power from being transmitted. Temperature is normally collected through thermistors on the aircraft which detect overheating in components, usually indicating imminent failure. Thermocouples are used on the test stand to provide a wider measurement range. Temperature and vibration analysis techniques can be used to provide managers with information that will allow them to achieve improved reliability and availability by detecting failures before they occur [13].

2.7 Digital Signal Acquisition

An analog signal is a signal that is continuous in both time and amplitude. In contrast, a digital signal is discrete in both the time and the amplitude and can only accept a finite number of values. The continuous time domain is used to convert a signal to the discrete time domain signal, where the analog signal is sampled at certain intervals of time [11]. When trying to find out the best method to collect digital signal the user needs to know the desired resolution, the sample rate, and the expected frequencies to measure.

2.8 Temperature Analysis

The temperature analysis used focuses on normal thresholds set on a components current temperature and thermal time gradient. Once it exceeds these limits, failure is expected. The short time between reaching the threshold limit and failure makes temperature monitoring a poor way to predict a components health. Despite the short time before failure, temperature may prove to be a good indicator of a change in the

system, such as grease loss, because the different operating condition might change the steady state temperature of the gearbox.

2.9 Vibration Analysis

Predictive maintenance through vibration is based on two ideas: (1) all common failure modes have unique vibration signatures that can be isolated and identified, and (2) the amplitude of that signature will not change unless altered by the system dynamics [13]. Discussed in the next sections are the CIs, based on time and frequency data, most relevant to the IGB, which was used in this experiment. The block diagram shown below in Figure 2.3 demonstrates how raw vibration data is used create a CI value that can be used to determine whether or not a vehicle is fit for continued use. Not only can the health of the component be observed, but the life of a component can be predicted by using certain techniques.

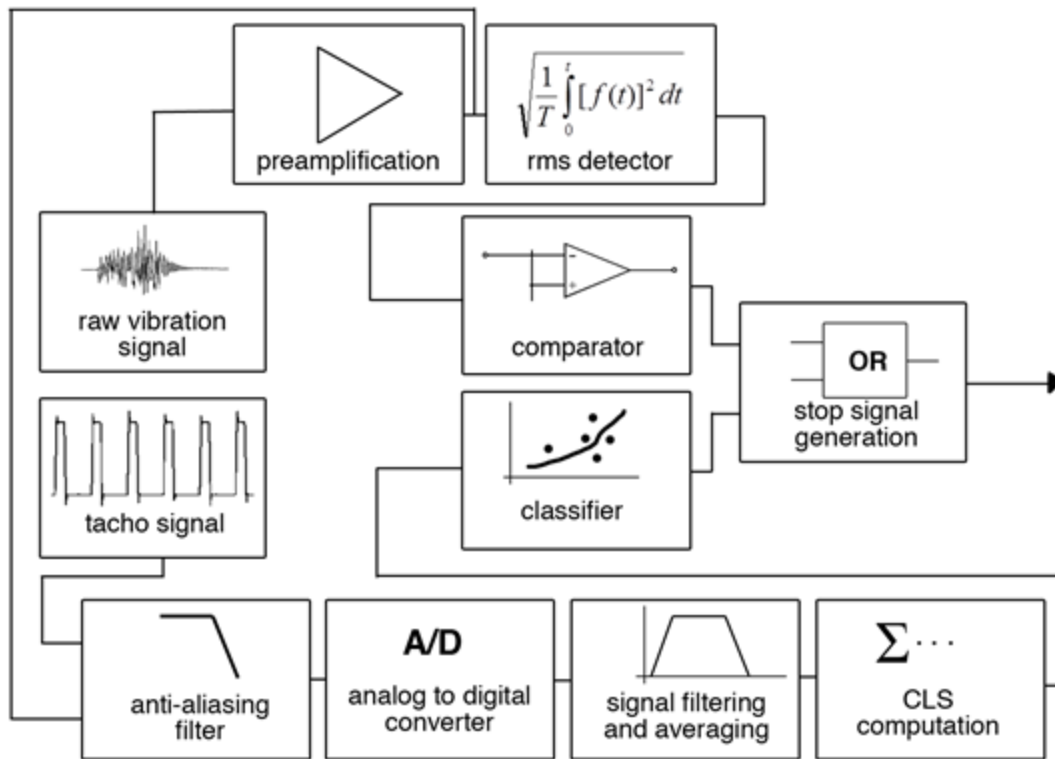

Figure 2.3 A flowchart of signal processing analysis [14]

2.10 Time-Domain Analysis

Time-domain data is the most basic form of data that comes from a vibration sensor; its output is vibration versus time. Time-domain plots are critical for all linear motion machinery, but are often difficult to use to diagnose one specific component in a system. Their ability to show the health of the system by representing the total displacement at any time does make them a useful tool for CBM practices [12].

2.10.1 RMS Value

The RMS value is a simple way to determine the shape of a waveform. For example, the RMS value of a 1 volt sine wave would be .707 volts, where a triangle wave

would be .577 volts. The main usage of this parameter is to view the overall condition of the gearbox without identifying exactly what is the problem [15].

$$RMS(x(n)) = \sqrt{\frac{1}{N} \sum_{n=1}^N x_n^2}$$

RMS is the root mean square value of dataset $x(n)$

x_n is a data series of length N

N is the number of points in dataset $x(n)$

2.10.2 Maximum Amplitude

The maximum amplitude is simply the peak of a waveform in either a time or frequency domain. Although it may be a simple concept, it can be a very powerful indicator of performance. It can be used to measure fault progression over a period of time because a larger defect should result in higher vibration.

2.10.3 Time Synchronous Average

Time synchronous averaging is a way of detecting a signal in uncorrelated noise by sampling based off a trigger (like a tachometer pulse) to achieve a better understanding of the condition of the system [21]. To do this properly, every frequency has to be analyzed individually. It is a useful parameter for identifying faults in a specific component because when comparing a certain frequency with an expected signal, the change and error can be calculated. An example is a small fluctuation in speed can look like a frequency shift even though no damage has occurred to the system. This particular error can be accounted for because the trigger for the average can be based off of

tachometer pulses rather than a theoretical number, but others cannot so a new domain analysis needs to be established.

2.11 Frequency-Domain Analysis

Frequency-domain analysis is the most widely used diagnostic tool for predictive maintenance. The main concept behind this parameter is changing the time series data into the frequency domain using integral techniques. Since the time domain only allows a fault to be established in the system and not further investigated another technique needs to be used. Frequency-domain analysis approaches are more precise, so condition monitoring that can focus on frequencies generated by an exact component, allowing analysis of faults directly instead of the entire systems response to the fault.

2.11.1 Fourier Transform

The Fourier Transform is the most widely used technique for getting frequency data. It is a very simple and efficient algorithm that saves valuable computational when calculating the standard discrete Fourier transform (DFT). The DFT takes a time domain signal and calculates all of the frequencies present in the signal. It is a lossless transformation where only the dependent variable is changed, the time domain to the frequency domain. This is a critical device when analyzing a device that is as sensitive to frequency changes as a drivetrain.

$$G(f) = \int_{-\infty}^{\infty} g(t) \exp(-i2\pi ft) dt$$

$G(f)$ is the representation of $g(t)$ in the frequency domain

$g(t)$ is any arbitrary signal in the time domain

2.11.2 Gear Failure Diagnostic Techniques

Gear signals normally yield harmonics of associated shaft speeds. The frequencies can be dependent on three different variables: tooth deflection due to the torque in the system which can cause spalls or cracks, an error in manufacturing which caused the tooth spacing to be off, and uniform wear over all the teeth [12]. The next condition indicator presented is the main source of data collected in this paper; although other techniques were used they did not yield the desired results.

2.11.3 Kurtosis

The absolute Kurtosis is defined as the fourth statistical moment of a signal about the mean of the signal [15]. The purpose of this tool is to identify how sharp the peaks are in any signal.

$$K = \frac{1}{N} \sum_{i=1}^N (x_i - \bar{x})^4$$

K is the Kurtosis of the signal x of length N

x_i is the amplitude of the signal of the i -th sample

\bar{x} is the arithmetic mean of the signal x

2.11.4 Fourth-Order Figure of Merit

The fourth-order figure of merit, FM4, was an early gear diagnostic technique of time-based data, and is considered to be one of the most promising of the early time-

based approaches [12]. It uses the Kurtosis of the current operating condition, generated by subtracting the time domain data from the baseline gear mesh pattern, and is then normalized by the difference signal's variance squared [9] (Figure 2.4). One of the only drawbacks of FM4 is that if more than one gear tooth fails, the response becomes less pronounced [15].

$$FM4 = \frac{N \sum_{i=1}^N (d_i - \bar{d})^4}{[\sum_{i=1}^N (d_i - \bar{d})^2]^2}$$

FM 4 is the fourth-order figure of merit

d_i is the amplitude of the i -th point of the difference signal

\bar{d} is the arithmetic mean of the difference signal d

N is the length of the difference signal

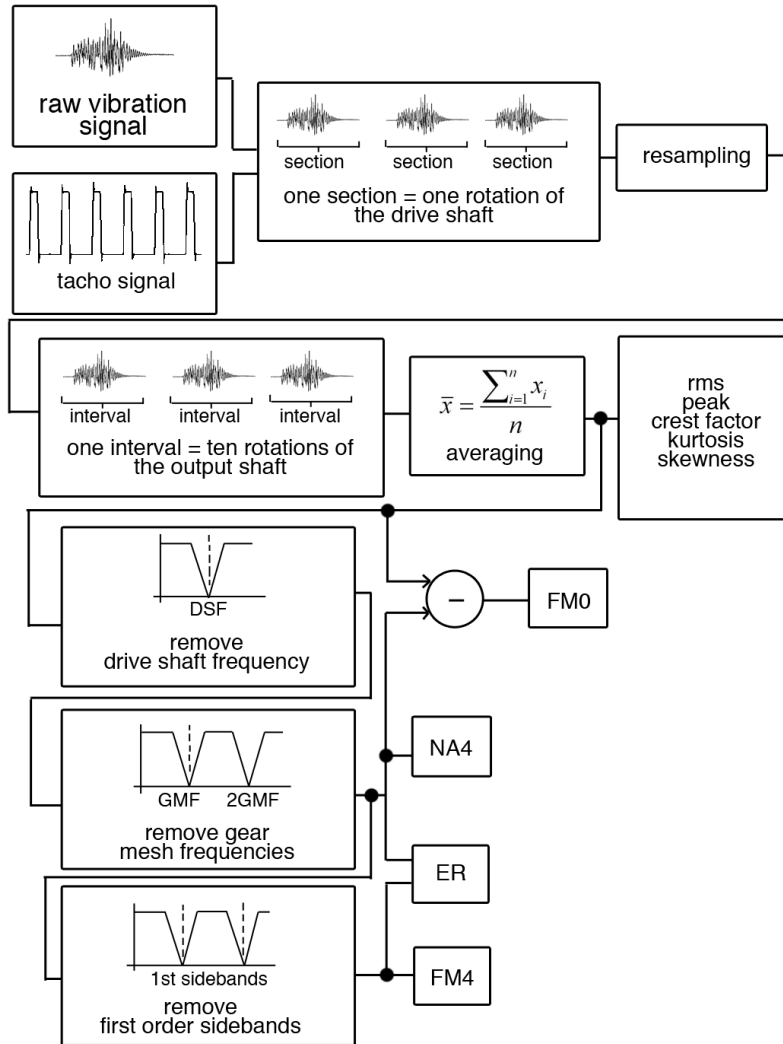

Figure 2.4 Flow chart of transforming raw vibration into a CI value [15]

2.11.5 Bearing Energy

Bearing Energy uses a bandwidth that includes the IGB's ball bearing frequencies and has reject frequencies that are associated with other drive shafts in the system [17]. There are no fault cases associated with this CI, and it is purely based on theoretical frequencies at which the ball bearings operate at in the IGB.

CHAPTER 3: EXPERIMENTAL PROGRAM AND TEST FACILITY

For over 15 years, the University of South Carolina (USC) has been collaborating with the South Carolina Army National Guard (SCARNG). Combined efforts between two parties led to a fully developed CBM Research Center within the USC Department of Mechanical Engineering that hosts several aircraft component test stands in support of CBM objectives. At the USC test stands, different CIs have been tested and validated to detect faults that occur over the lifetime of various drivetrain articles including such components as the AH-64D forward hanger bearing, aft hanger bearing, IGB, TGB, and tail rotor swashplate (TRSP) (Figure3.1).

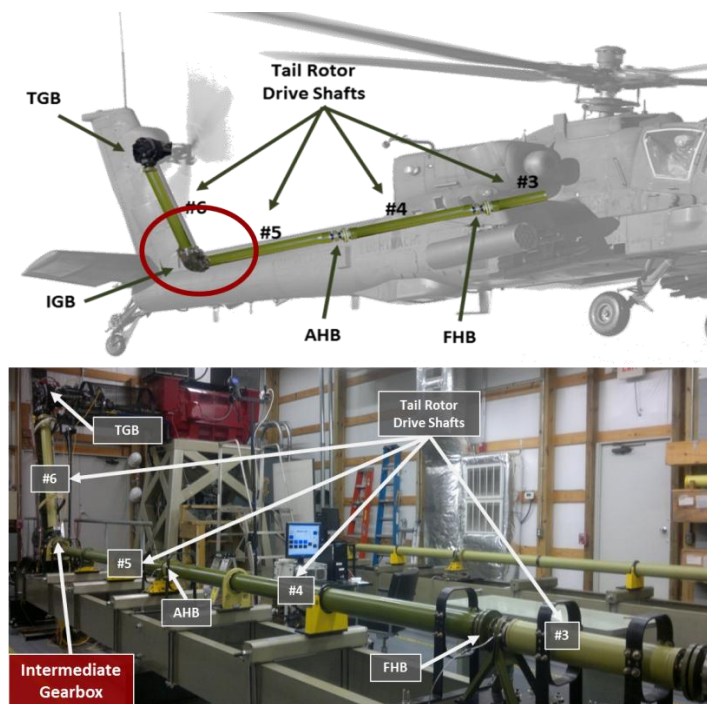

Figure 3.1 Comparison between the aircraft and USC test stand

The test stand emulates the complete tail rotor drivetrain (TRDT) from the main transmission to the tail rotor swashplate assembly. The TRDT is comprised of actual aircraft hardware and is capable of handling drive shafts installed at the maximum allowable misalignment of two degrees. Structure, instrumentation, data acquisition systems, and supporting hardware are installed according to military standards. The test stand's two 800 horsepower motors are capable of exceeding 150% of the actual aircraft drivetrain loading. The test stand was designed and built to accommodate the use of various HUMS and is currently equipped with a Honeywell MSPU. USC's own data acquisition results have been validated with data obtained from actual airframes. The testing facility is also capable of being modified to test new and existing drivetrain components of military and civilian aircraft, including the ARH-70, CH-47, and UH-60 drivetrains [1].

3.1 IGB

The purpose of the IGB on the AH-64D is to change the drive direction as well as output speed. The main components of the IGB are the input rolling bearing, input duplex bearing, output duplex bearing, and output roller bearing (Figure 3.2). The IGB is outfitted with two accelerometers and four thermocouples. The accelerometer and thermocouple positions are identical to what can be found on the aircraft.

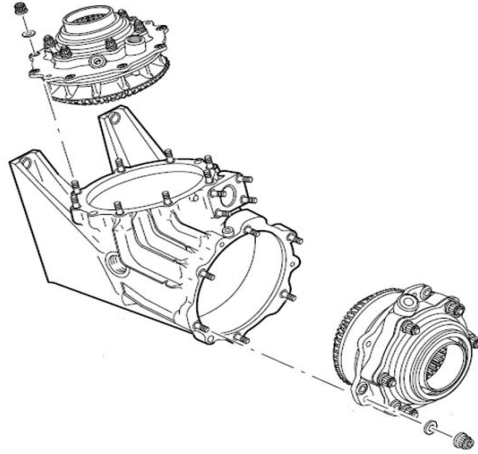

Figure 3.2 Internal view of the IGB [7]

3.2 Instrumentation and Data Acquisition System

3.2.1 MSPU

The MSPU is a Honeywell product that is the standard data acquisition unit for all AH-64 aircraft participating in the HUMS program. It contains a high speed data acquisition card, which can accommodate up to 36 accelerometer channels with bandwidth of 1.5 KHz to 96 KHz, eight tachometers, two blade tracker channels, eight general purpose analog or discrete channels, and eight low level analog signals [16]. Additional features of the MSPU include having a built in sensor test function to allow the maintainer to diagnosis if a sensor is functioning correctly. It also has the capability to calculate additional parameters which have been deemed by the aviation engineering directorate (AED) as reliable to diagnose the mechanical systems through vibration. The MSPU displays its results through a graphic user interface program known as PC-Ground Based Station (GBS), which shows the user the current condition of each component on the aircraft.



Figure 3.3 Model of MSPU

3.2.2 Data Acquisition (DAQ)

Since the MSPU only outputs processed data, a second data acquisition unit is required to capture raw vibration results and monitor additional parameters. USC has equipped its test facility with a modular National Instruments DAQ unit with vibration sensors and thermocouples which collect data off of the input motor, forward hanger bearing, aft hanger bearing, intermediate gearbox, tail rotor gearbox, and tail rotor swashplate. Other sensors have also been installed that allow for the collection of speed and torque from both the input and output motor.

Data monitoring, storage and system control are all handled through the National Instruments hardware, programmed in the LabVIEW environment. Operators monitor the data on indicators that display current sensor values necessary to determine the correct operation of the facility. In addition, the software has built in checks that check the current value against the cut-off value used on the aircraft and alert the operator if the stand is in an unsafe operating mode.

On the back end, data is stored at different rates to facilitate analysis after runs are completed. Temperature data is recorded at 30 Hz because it changes slowly over a run. Speed and torque are updated at 60 Hz, since the load steps are changed quickly and vibration is recorded at the fastest rate, 48 kHz.

3.2.3 Instrumentation

To replicate the data coming off of the MSPU the sensors that are used for USC's DAQ are in close proximity and in the same orientation as the military devices (Figure 3.4). The test stand is equipped with two different types of accelerometers, a spark plug and bracket type. The spark plug configuration is a Dytran 3062A accelerometer that has a frequency range of .48 Hz to 10 kHz and can read up to 500 G's. The Dytran 3077A is the bracket style accelerometer used on the stand and it covers the frequencies from .5 Hz to 5 kHz and can read up to 500 G's.

The thermocouples on the test stand are in the same location as where the thermistors would be on the aircraft. The thermocouples used are Type K, which is the most inexpensive and common style used, and have the capability to read between -201 °C and 1349 °F, which is well within the gearbox operating range. In spite of their commonality, the sensitivity, $41\mu\text{V}/^\circ\text{C}$, is accurate enough for this application, making the Type K thermocouple the best candidate for temperature measurement.

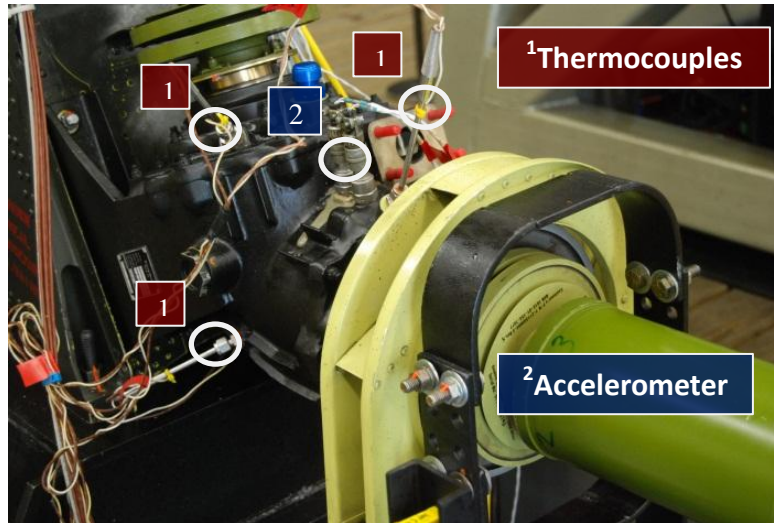

Figure 3.4 Sensor layout of the IGB

CHAPTER 4: EXPERIMENTAL PROCEDURES

This experiment was conducted using three intermediate gearboxes, each run at five different service levels of grease (0%, 25%, 50%, 75%, and 100%); these levels will be calculated based off of the Army standard for a fully lubricated gearbox (964 grams of grease). These tests totaled approximately 34 hours of testing. It was decided that all of the gearboxes should start at 0% grease and increase to 100% as shown in Table 4.1.

Table 4.1. List of Tests

Test #	Serial #	Grease %
1	1	0
2	1	25
3	1	50
4	1	75
5	1	100
6	2	0
7	2	25
8	2	50
9	2	75
10	2	100
11	3	0
12	3	25
13	3	50
14	3	75
15	3	100

4.1 Gearbox Changeout

After every fifth test in Table 4.1 the IGB was removed and left to sit overnight twice, filled with an oil based solution for the first night and denatured alcohol the

second. A borescope was used to check the lubrication level of the gearbox(Figure 4.1). During this part of the procedure, any damage to the gearbox could be noted.



Figure 4.1 A comparison, from a previous experiment, of worn gear teeth (left) to healthy teeth (right)

4.2 Pre-run Procedures

The operators consider the test stand as an actual aircraft and it is treated with the same standards. Before each run, an inspection of the test stand is conducted. Additional inspection measures were implemented (i.e. grease ejection monitoring, and the removal of unnecessary equipment from the test stand since a new experiment was being conducted). Additionally, the operators carefully monitor the data collection equipment to ensure the measurements appear accurate and the ejected grease is collected. Excess burped grease would normally dispense over the gearbox, but a special collection device was constructed so the amount ejected could accurately be quantified (Figure 4.2).



Figure 4.2 Breather port adapter setup

4.3 Running Procedures

The USC TRDT test stand operated with the standard test profile, shown in Table 4.2, built to simulate the flight characteristics of the AH-64D gearboxes. These numbers were agreed upon by AED and USC as the load steps to best represent the damage accrued by the gearboxes during flight. Flat Pitch Ground (FPG) 101 is when the aircraft is sitting with no pitch in the blades and the rotor is running at 101% of maximum speed, approximately 4863 rpm. During this time, a survey is taken and data is collected by the MSPU and used to create a CI.

Table 4.2. Modified TRDT Load Profile

Load Step	Run Time (minutes)	Elapsed Time (minutes)	Speed (rpm)	Torque (ft-lbs)	HP
FPG 101	00:05-00:15	10	4863	111	30
Normal	00:15-01:05	50	4863	371	100
FPG 101	01:05-01:15	10	4863	111	30
Normal	01:15-02:05	50	4863	979	264
FPG 101	02:05-02:15	10	4863	111	30

CHAPTER 5: EXPERIMENTAL RESULTS AND DISCUSSION OF CURRENT CONDITION INDICATORS

The main objective of this experiment was to determine if a trend for vibration with different grease service levels exists across multiple gearboxes. This analysis was done for three different gearboxes by using two different vibration analysis techniques: one used the CI values from the MSPU (Figure 5.1) and the other was looking at known frequencies of interest in the raw vibration data. The CI values were taken directly from the PC-GBS. The raw vibration data was collected by the USC DAQ at 48 kHz from an accelerometer in a similar position to that of the aircraft standard.

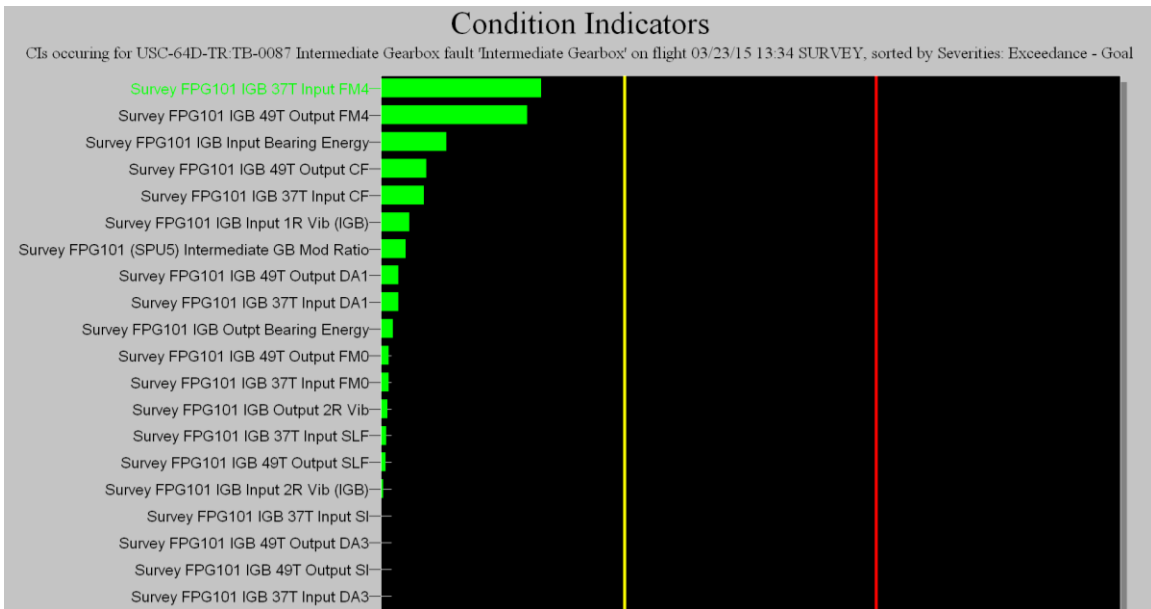

Figure 5.1 List of IGB condition indicators monitored by the MSPU

5.1 Raw Vibration Results

The raw vibration results were collected off of the USC DAQ and analyzed using a FFT. A list of important operating frequencies of the IGB was used to analyze the data. A band of $\pm 1\%$ was placed on the important frequencies to account for shifts in peaks due to this analysis being done on a real system which may not have the same aircraft standard operational speed of 4863 rpm every time it conducts an experiment. An example FFT is shown below as well as some of the results from the IGBs (Figure 5.2).

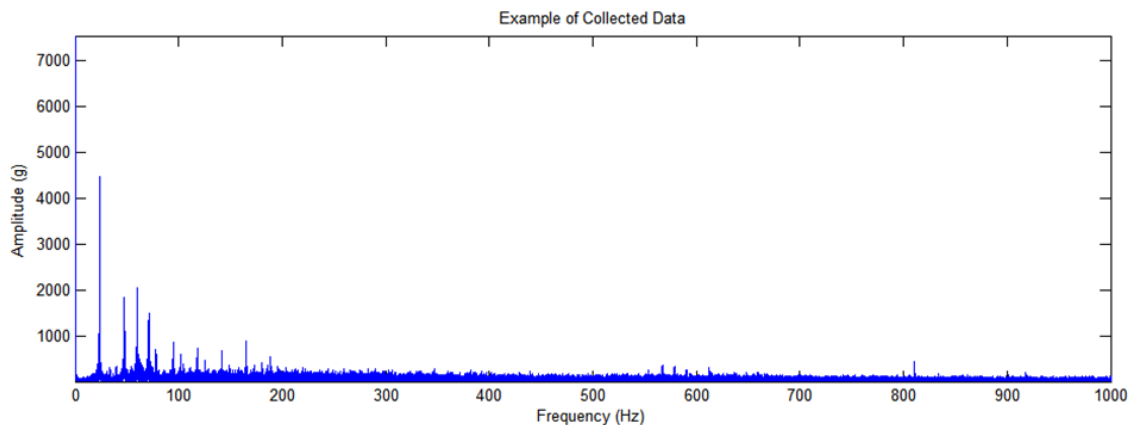

Figure 5.2 Example of a FFT made from vibration data

It has been proven that it is possible to identify the vibration signatures of different components of the system from a sensor located on a single component. For example, when looking at the IGB vibration data, the natural frequencies of the aft hanger bearing can be observed in the results taken from the IGB. Although this interference makes it harder to observe trends in the data of a single component, it allows a more complete model to be produced because it accurately represents the entire aircraft much better than a stand-alone test bed that only runs a single component. In this experiment

the extra data is filtered out and the results are based only on the IGB frequencies of interest.

The IGB frequency results were computed using the method stated above by selecting the magnitude of vibration at nearly 80 different frequencies. These come from the Army's list of calculated natural frequencies of the system components visible from IGB sensors. These results were graphed and the slope was compared between gearboxes at different service levels. A sample of these results for three frequencies (25.51 Hz, 27 Hz, and 33.78 Hz) is graphed below (Figure 5.3-5.4); the full list of slopes can be found in Appendix B.

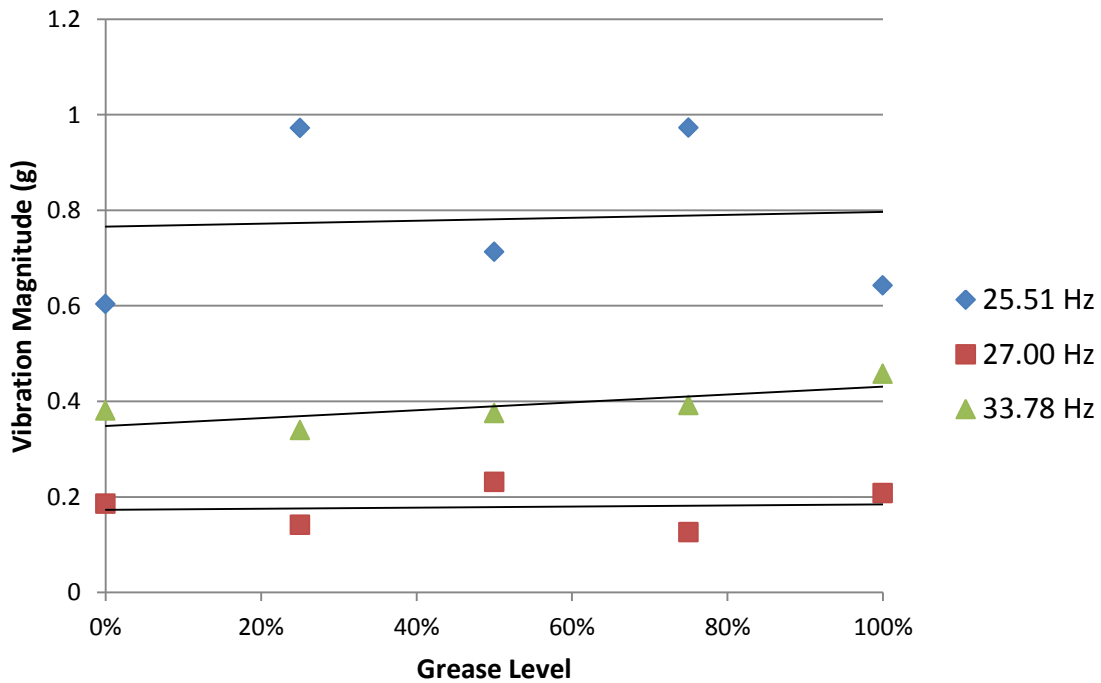

Figure 5.3 Gearbox #1 vibration results

The three frequencies shown above are just an example of all the frequencies analyzed. The ideal trend would be downward starting at 0% grease and ending linearly at 100% grease. None of the frequencies for gearbox #1 display this trend, including the

example frequencies: 25.51 Hz magnitude has a small trend upward, the 27 Hz result has no trend, and the 33.87 Hz result has a slight upward trend.

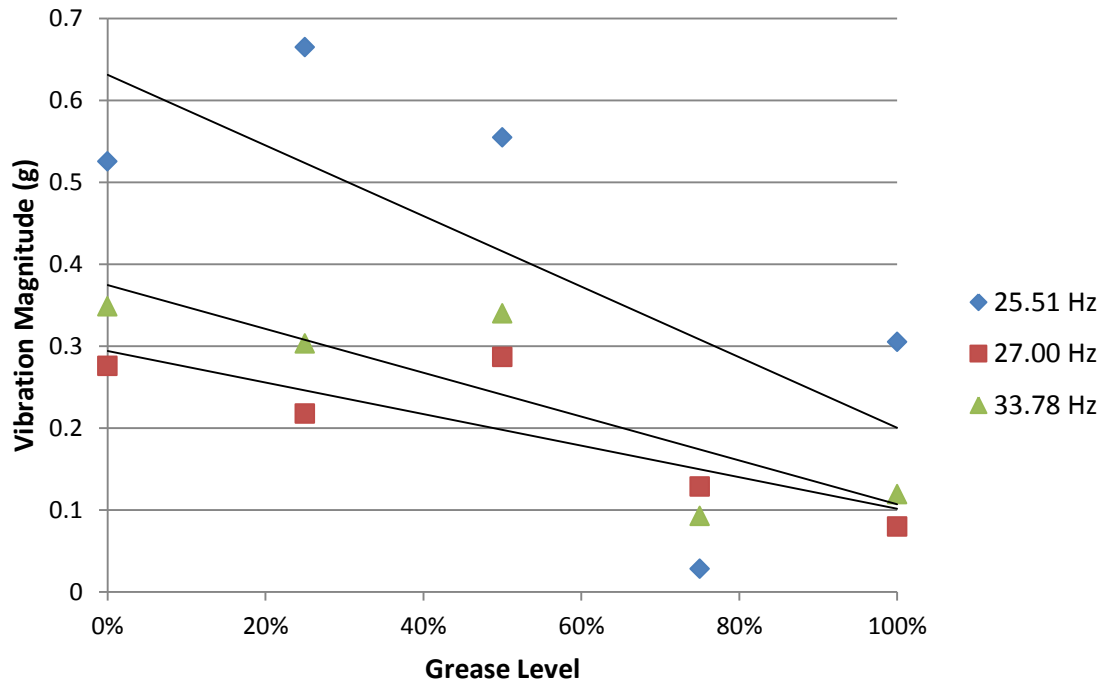

Figure 5.4 Gearbox #3 vibration results

For gearbox #3 the results are exactly what were expected coming into this experiment. All of the frequencies shown above have a sharp downward trend starting 0% grease level going to 100%. However, they are not ideal because the points do not directly trend down, an example of this is in the 25.51 Hz result, the 25% and 50% vibration magnitude were higher than 0%, and the 75% data point was lower than 100%.

Although the three example frequencies in gearbox #3 displayed the expected a sharp downward trend as grease level increased versus vibration the results were not consistent with gearbox #1. The non-repeatability between gearboxes makes the grease estimation through the vibration's maximum amplitude a poor indicator for the aircraft.

Since there was no correlation between the frequencies for both gearboxes no further analysis was done for those values. After analyzing the rest of the critical frequencies for the IGB in a similar fashion to the process that was described above, it was concluded that none of the frequencies displayed the ideal characteristic of a lower vibration level as grease level increased for any of the gearboxes tested. This could have been due to a small amount of data points analyzed which could have been the cause for the less than ideal results. More points analyzed could have also led to a stronger result showing that there was no correlation to the data. The vibration for the gearboxes was further processed to establish a trend between vibration and grease level.

5.2 MSPU CI Results

The MSPU calculates 24 different CI values for the IGB. All of these values were graphed with respect to grease service level and then compared to one another based on gearbox. Out of all the CI's analyzed, only two had a common correlation between vibration amplitude and grease service level, Output Bearing Energy and Input Bearing Energy, for that reason only the results for these indicators are shown. The vibration plots are displayed to put emphasis on the trend for each gearbox through all the grease level changes. The figures below (Figure 5.5-5.7) each show the data for one run broken up by CI. During the course of a run, the vibration is expected to decrease because the grease has a break-in period and then after that time the changing conditions will not affect the grease performance. The additional figures at the end of the section (Figure 5.8-5.9) are the normalized results for the two promising CI values for all of the gearboxes tested.

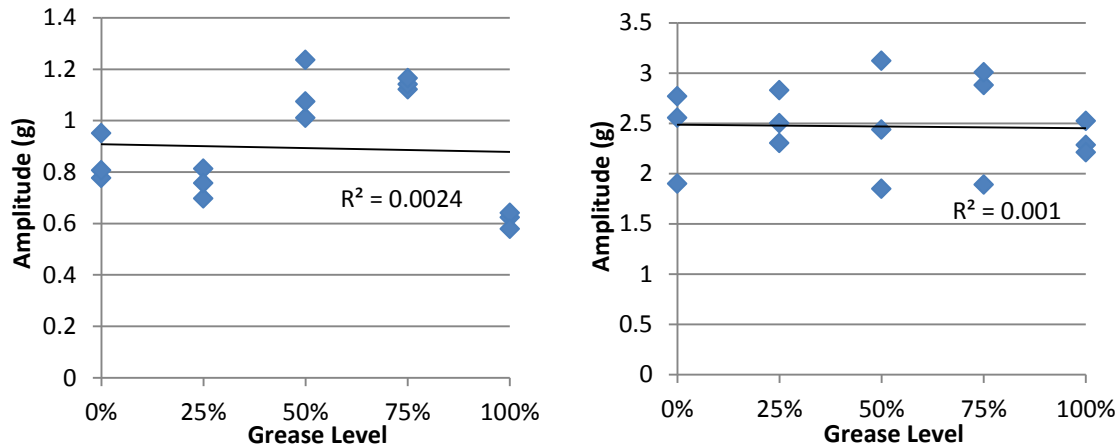

Figure 5.5 Graph displaying two CI values for gearbox #1, Output Bearing Energy(Left) and Input Bearing Energy(Right)

The MSPU vibration results displayed in the figure above show little correlation for vibration being a good indicator for grease level. The data trend for both output and input bearing energy are varied for gearbox #1 with several grease service levels having higher amplitude than the lower level. However, the results do display a negative trend as grease level increases making them an acceptable candidate for further analysis.

It is theorized that the CI values have dispersion between the grease levels because they were run at different torque values before a survey was taken, so that the progression upward by the vibration amplitude at a certain grease level is a product of the increased torque load on the gearbox. This phenomenon is clearly shown (Figure 5.5) and is evident throughout the rest of the results.

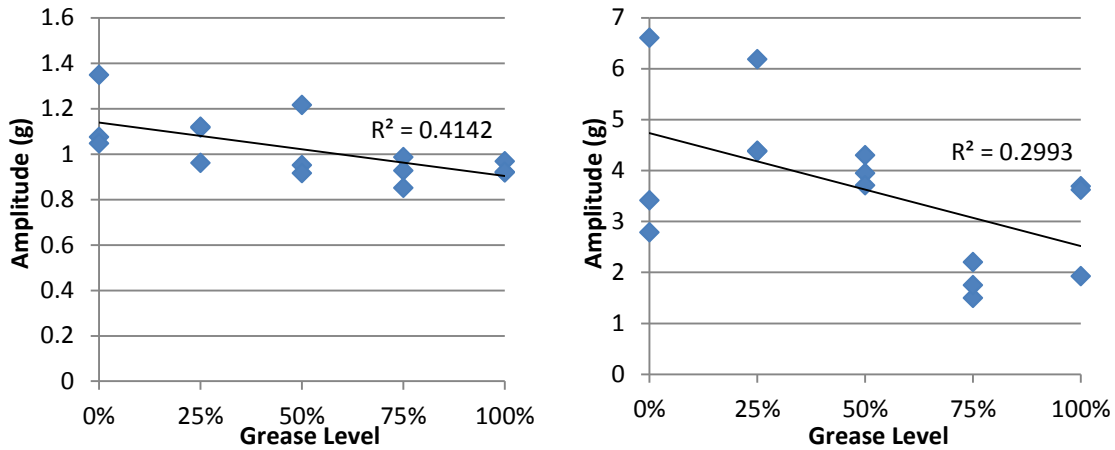

Figure 5.6 Graph displaying two CI values for gearbox #2, Output Bearing Energy(Left) and Input Bearing Energy(Right)

The MSPU vibration results for gearbox #2 display a better trend than the first gearbox analyzed when considering input and output bearing energy. The correlation for output bearing energy is very high and has a downward trend that does not contain as many points that have a higher vibration level for a lower grease level. The input bearing energy has a higher slope but there is one point, the 75% grease service level, where the vibration is lower than a higher grease service level, 100%. Some of the grease service levels may appear to only have two data points, but in actuality they have three because there is some overlap between two of the results. Overall, this gearbox shows the desired trend of lower vibration amplitude as grease service level increases, and justifies further research for another gearbox to be examined.

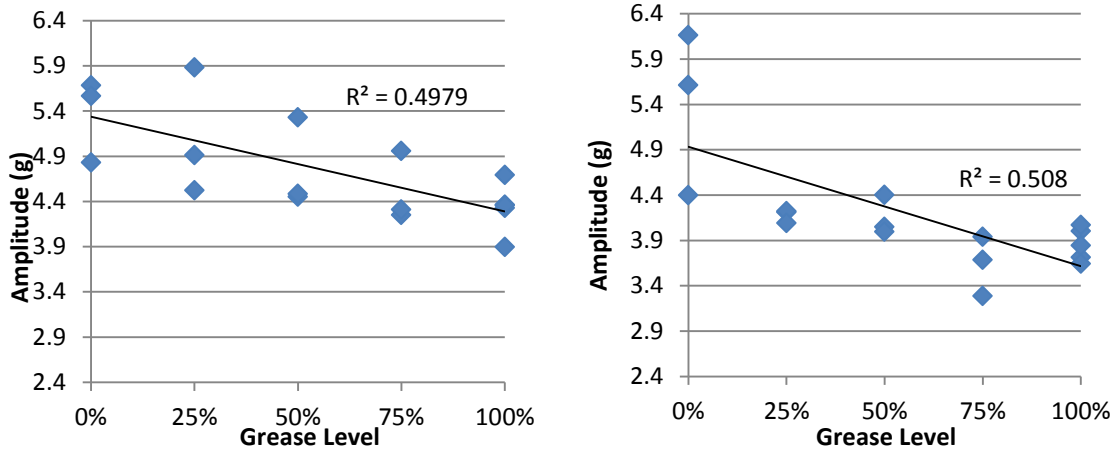

Figure 5.7 Graph displaying two CI values for gearbox #3, Output Bearing Energy(Left) and Input Bearing Energy(Right)

For gearbox #3 the MSPU vibration results for input and output bearing energy were nearly identical to what was expected from the condition indicators versus grease service level. Overall the condition indicators were lower than the previous grease level except for the 25% iteration for the output bearing energy. The trend for the input bearing energy CI was not as stable it raised and lowered from grease level to grease level, but ultimately resulted in a high correlation for the results.

To make sure that these were the best CI values to conduct future analysis with for grease level detection, all of the gearbox results were graphed together in one figure and analyzed (Figure 5.8-5.9). These results were normalized to account for the different baseline vibration levels that were recorded for each gearbox so that they could be compared against one another.

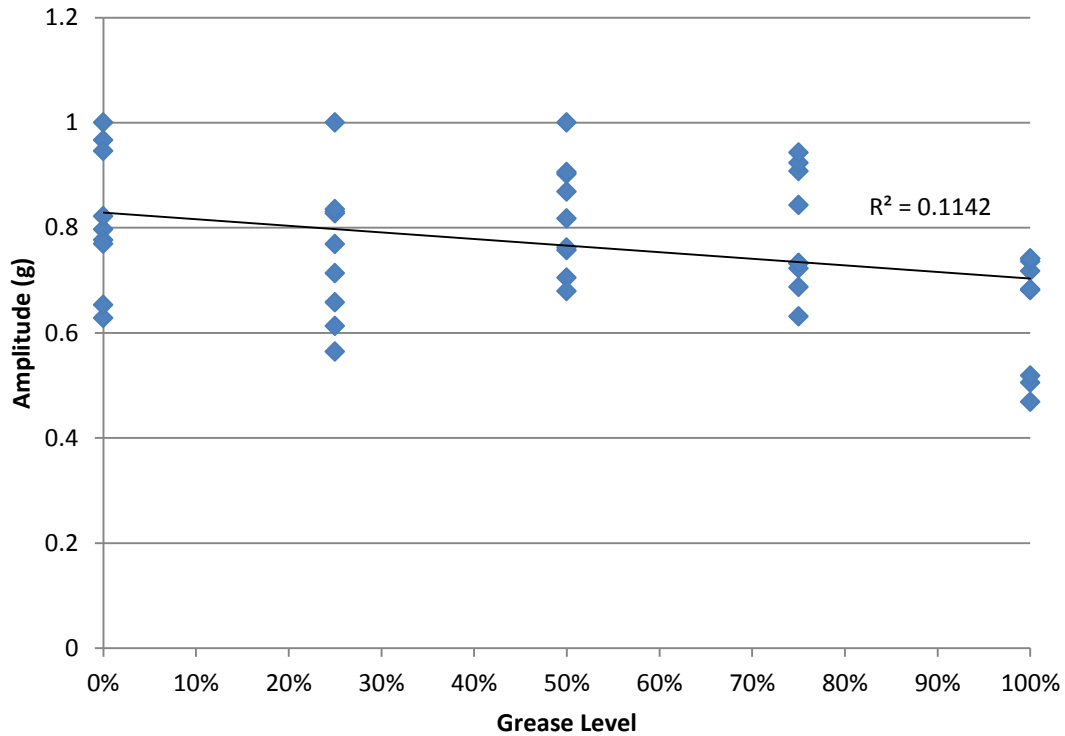

Figure 5.8 Graph displaying normalized Output Bearing Energy CI results across gearboxes

The results for the output bearing energy display a negative trend of time that confirms the expected results. There are also no grease levels that had a higher vibration value than the previous result making it a good candidate for grease level prediction. There was a 34% correlation resulting in a moderately negative relationship between the Output Bearing Energy CI magnitude levels and the grease levels.

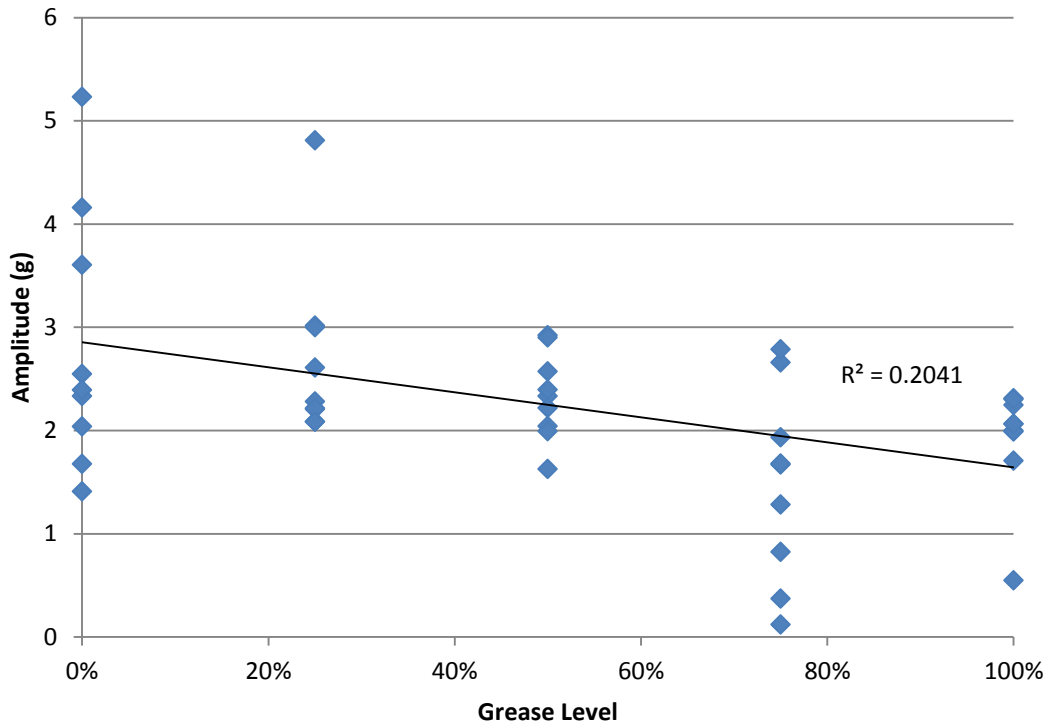

Figure 5.9 Graph displaying normalized Input Bearing Energy CI results across gearboxes

The correlation between Input Bearing Energy CI and grease level was 45% resulting in a moderately negative correlation. This is a stronger trend than output bearing energy making it a better indicator for grease level than output bearing energy. Like the previously investigated CI, input bearing energy also showed no signs of the grease level having a vibration magnitude than the previous amount.

All of the gearboxes exhibited all of the expected characteristics in this experiment through the Input Bearing Energy CI and the Output Bearing Energy CI. When changing grease levels from run to run all of the resulting trends from the input and output bearing energy had negative trends.

These results are exactly what were expected to occur; that the less grease a gearbox contains the higher the vibration level of that component will be. Using these

MSPU algorithms show improvement over the trend of vibration frequencies of interest, because they monitor a wide range of frequencies.

5.3 Temperature Results

On the aircraft, temperature plays an important role as an indicator for the health of a component. The purpose of temperature readings throughout testing was to make sure that the article was not being damaged due to running in a state with a low grease service level. Like vibration qualities, each gearbox has a different standard operating temperature. When that value starts to increase rapidly, it is a good indicator that the component is going to fail shortly. The 0% grease service level was originally believed to have the highest average temperature because there is more friction at the gear contact surfaces of the gearbox. Thermal readings are taken on the IGB at the input duplex bearing, input rolling bearing, output duplex bearing, and output roller bearing. For visual purposes these values were averaged together and plotted for each run conducted on a gearbox (Figure 5.10-Figure 5.12).

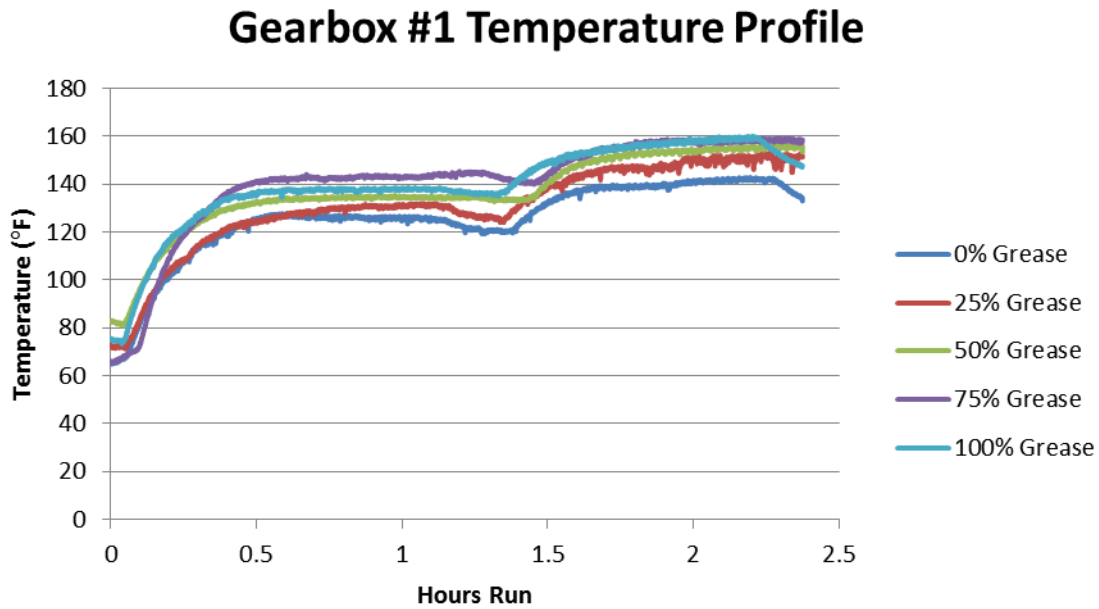

Figure 5.10 Temperature of gearbox #1 at various grease levels

After analyzing the results from gearbox #1, it can be seen that there is not a very noticeable change from run to run. An interesting result is that the temperature actually increased as the amount of grease increased, from 130.8°F average temperature at 0% grease to 139.7°F at 100% grease (Figure 5.11). It is important to note that the torque affects the temperature of the grease. This is seen at the beginning of the run when the torque is at 371 ft.-lbs. and goes back down around the one hour mark because a survey is taken at 111 ft.-lbs. It increases again at the last value of 979 ft.-lbs. All of the gearboxes in this experiment were tested in the same facility with an ambient temperature around 75°F ± 5°F, which explains the lower starting temperature of each grease service level.

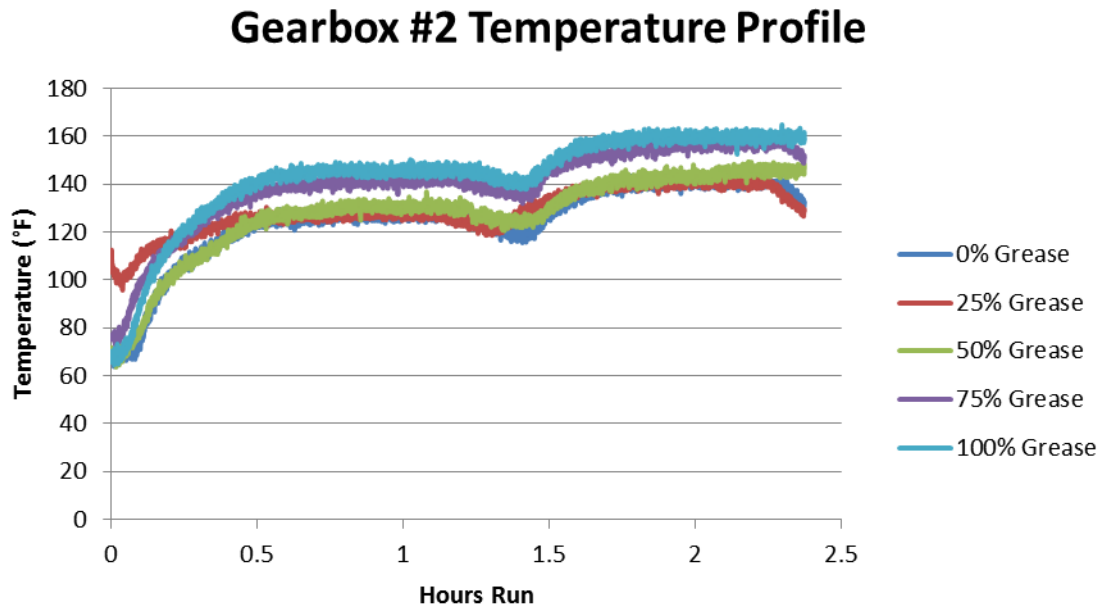

Figure 5.11 Temperature of gearbox #2 at various grease levels

The temperature profile for gearbox #2 shows similar results to the first test article. The gradient increases with the service level, but it is not by a great amount (Figure 5.12). The average temperature for the 0% grease run was 125.1°F and for 100% grease it was 143.8°F. The increase in temperature due to torque is still evident in this gearbox, as it can be seen temperature drops down at a lower torque around 1.4 hours due to a survey being taken. The temperature for the 25% run is initially higher, due to being run just after a previous test was conducted and still having residual temperature in the gearbox box, but it does not have any effect on the temperature results.

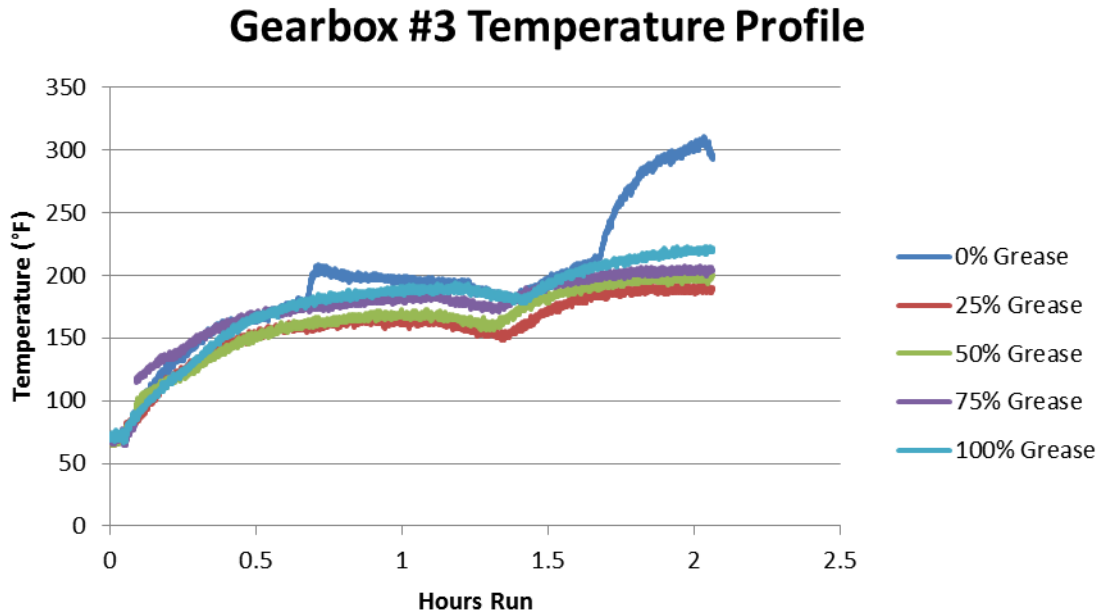

Figure 5.12 Temperature of gearbox #3 at various grease levels

Gearbox #3 shows some of the characteristics of an expected trend for a gearbox with different grease levels (Figure 5.13). Although the 100% grease is the second highest average temperature value, the largest is the 0% grease value. The lowest average temperature for this article was at 25% grease at 160°F and has a maximum average value of 198°F with the gearbox running on no grease. Again it can be noted that with the exception of the 0% grease run the 100% grease article had the highest average temperature. It was determined that the 0% grease level was two standard deviations away from the mean and considered to be an outlier and was not used for any further analysis.

When placing the average values on one graph an interesting trend is observed. That for all of the gearboxes there was a positive trend for temperature when more grease was added to a gearbox as seen in Figure 5.13.

Temperature- Lubrication Level Correlation

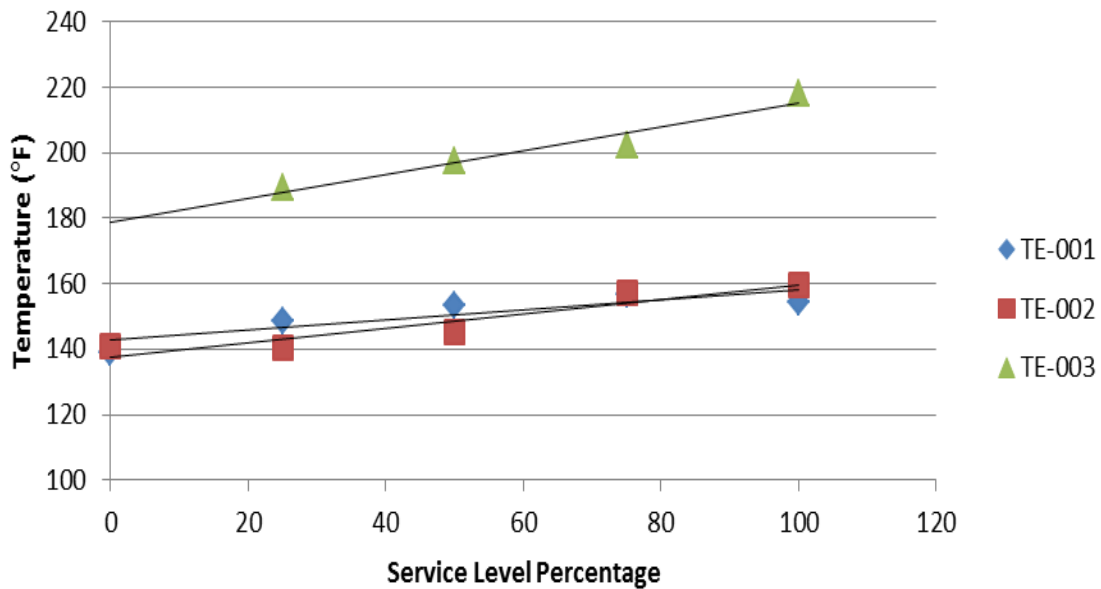

Figure 5.13 Temperature correlation to grease lubrication level

This graph may be the most stable way to determine the lubrication level of a gearbox on the AH-64. The slope of each of the lines is very similar between each gearbox. Note that the 0% grease temperature reading for TE-003 was removed because it was more than two standard deviations from the mean, making it an outlier. As such, the potential of using temperature as an indicator of service level is very high. The resulting slope of the line indicates that the correlation between temperature and grease is a 6°F drop per every 25% of grease lost from the gearbox. Possible explanations for the positive correlation between temperature and grease level are that the grease is an additional resistance to the gear system and it allows the hottest parts of the gearbox to influence the measurement points through the conductivity of the grease.

5.4 Sensor Fusion Results

Since the expected correlation between grease service level and sensor data were observed from the output bearing condition indicator, input bearing condition indicator, and temperature further analysis was conducted to come up with a better predictor of grease than what was obtained from each sensor individually. To do this, SPSS Modeler Version 16 was used to statistically analyze all of the condition indicators obtained from the MSPU and temperature results, and then the best combination to predict the level of grease in the gearbox based on a test set of data the was displayed. Based on this method the following equation was returned as the best predictor of grease service level.

$$EL = A * Temperature + B * Input Bearing Energy + C$$

EL is the estimated grease level

A is constant of value 0.007906

B is constant of value -0.0115

C is constant of value -0.008396

The resulting equation excluded the output bearing condition indicator because SPSS found that it did not add a significant change to the overall prediction equation. Following this equation a graph of grease prediction was formed based on testing data (Figure 5.14). This confirms my results found in the MSPU results section because out of all the MSPU CIs SPSS analyzed, one of strongest indicators of grease loss was input bearing energy.

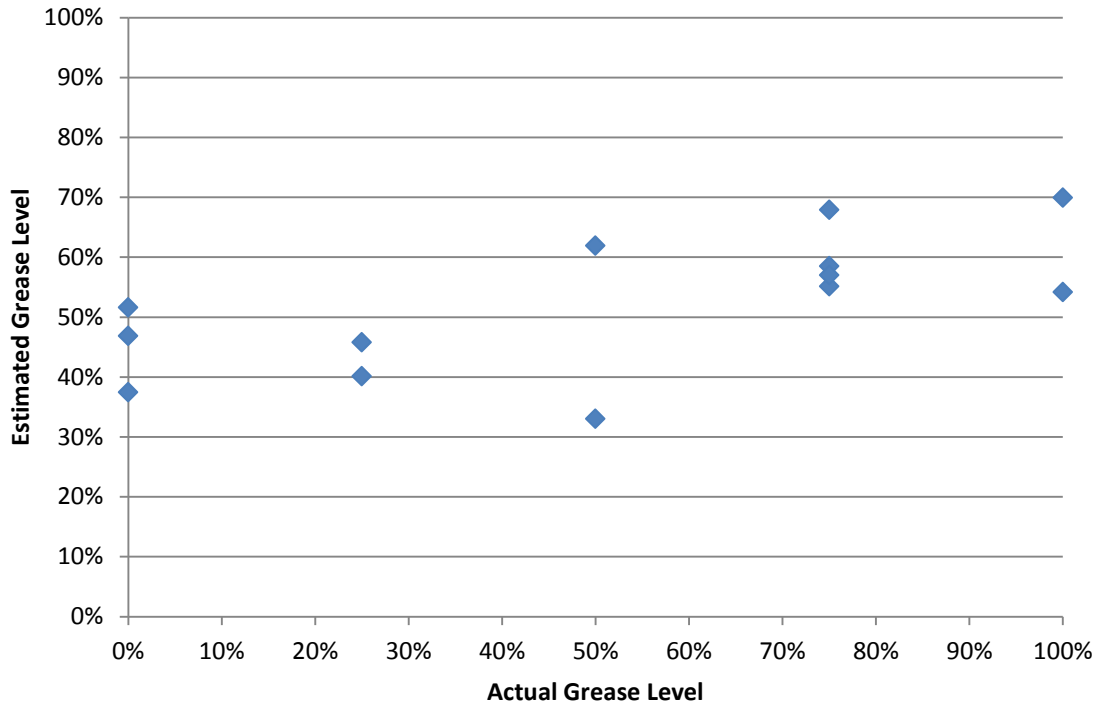

Figure 5.14 Estimated grease level based on the sensor fusion equation created

As shown in the figure, the equation does not yield optimal results for correlating the two sensor results to grease level. It does well at predicting the 50% and 75% values, but is very poor when trying to estimate 0%, 25%, and 100%. This small correlation could be due to the fact that enough data points were not collected during the run so there is not enough data available to make an accurate prediction of the grease level. This could have been improved by taking more surveys during the runs, by making the experiments longer, or running more tests on each gearbox.

5.5 Grease Ejection Results

A secondary objective of the study was to try and quantify the amount of grease that “burps” from the gearbox when it is fully serviced to the depot standard of 964 grams of lubricant. If the amount cannot be standardized amongst all gearboxes then it could

possibly be shown that the each gearbox has a unique service level at which it prefers to operate at.

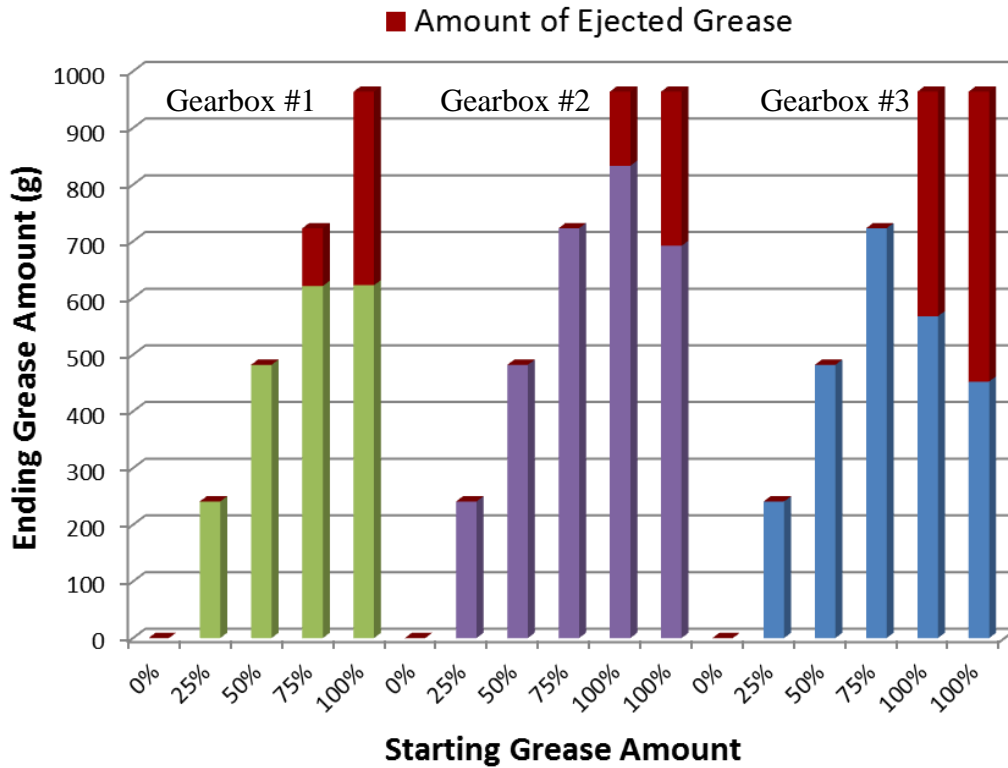

Figure 5.15 Grease ejections for different gear boxes

When looking at the results presented in Figure 5.15 it is clear that current Army practice of filling the gearbox with 964 grams of grease can be continued. However, the procedure suggested by these results is to allow the gearbox to find its own equilibrium at which it operates by filling the component to the recommended level and letting it adjust to its proper level by burping excess grease. Once this level has been established no more grease should be added to the gearbox to prevent unnecessary maintenance. The key to this practice is not servicing the gearbox again because it will just eject the grease back out and it will end up not only frustrating the maintainer, but causing him

unnecessary work. It is important to note that after a gearbox ejects grease it should be a common practice that the new amount be considered the 100% service level [18]. The results agree with this rationale because there was only one gearbox, gearbox #1 that ejected the same amount of grease as the previous run, which was still 65% of the 964 gram recommended service level. The results from all of the components tested seem to indicate that the amount of grease ejected is a random amount and is unique to each gearbox.

CHAPTER 6: CONCLUSION

The operational characteristics of the gearbox drivetrain components on the AH-64D are unique to an individual article. Throughout this paper, the differences between individual gearboxes can be seen in all of the condition metrics used to quantify the health of the gearboxes. Not only are the magnitudes of vibration are different from gearbox to gearbox, they also vary with changing grease levels. Temperature is another aspect in which their unique qualities are shown because, although design is the same, the operating temperature is still different between them. These results show the difficulty in creating a standard indicator for grease service level because there is variation between gearboxes. A secondary part of this experiment was to try and find a constant service level for all of the gearboxes to avoid the grease ejection issue. It was determined that each gearbox burped a different amount of grease even when being run multiple times at a full service level. According to these results, each gearbox should be theoretically over serviced and then allowed to find its own 100% service level instead of filling it up to a standard amount when it will just burp the extra immediately.

The experiments establish a moderately negative correlation between Input Bearing Energy CI and grease level in addition to a moderately negative relationship between the Output Bearing Energy CI magnitude levels and the grease levels so that with the proper CIs, a low grease level will result in a higher vibration magnitude. If implemented on the aircraft it will improve morale because unnecessary components no

longer have to be serviced. This will lead to a large cost avoidance and time saving because excessive maintenance no longer has to be conducted. The results prove that a correlation exists, but this data should not instantly be applied to an aircraft because of the small population sample. This conclusion is affirmed in the sensor fusion results because when vibration data and temperature data are merged together in SPSS, there is not enough sensor data to yield an accurate model. This could have been corrected in this work by shortening the loaded periods and increasing the amount of surveys taken during a run, thus increasing the amount of data points. The area that shows the most promise for future implementation is temperature. The correlation between temperature and lubrication service level is very evident and shows similarities between all of the gearboxes tested, making it the best indicator of grease loss. By using a controlled environment, the ambient temperature was relatively the same for each run. Conducting each baseline at different temperatures could have had led to false positive results.

There are a few objectives for future work: one is to increase the diversity of analysis algorithms, the second is increase the number of different gearboxes used in sampling, and the last is to try and use the temperature trends collected and implement them on gearboxes with unknown service levels. The two algorithms used in this paper are standard on the MSPU, but, as mentioned before, are not tuned to detect grease leakage. Furthermore, research into other factors in gearbox vibration response may help eliminate variables from our consideration. How different faults affect the gearbox and its response to other problems not entirely characterized so further research into this area would help determine how much of the response is due to grease and how much is due to the historic faults of the that gearbox reacting to the different loadings and conditions of

the test stand. This work could be further analyzed on the intermediate gearbox box or another aircraft component. The technique and type of data collected will remain the same no matter what component the testing is completed on.

Ultimately, this proves that the CBM practice works and can actually help create new innovations in the field. If a new CI can be created that accurately tracks the amount of grease in a machine, this can be very helpful to any application, not just aviation, especially if the component is in a confined space and cannot be checked frequently. By continuing to innovate this field everyone can benefit from data collected from normal operation to experiment conducted like this one.

REFERENCES

- [1] Nicholas Goodman, Abdel Bayoumi, Vytautas Blechertas, Ronak Shah, and Yong-June Shin. "CBM Component Testing at the University of South Carolina: AH-64 Tail Rotor Gearbox Studies". American Helicopter Society Technical Specialists' Meeting on Condition Based Maintenance conference proceedings. 2009.
- [2] N. Goodman, "Application of data mining algorithms for the improvement and synthesis of diagnostic metrics for rotating machinery". PhD dissertation, University of South Carolina, 2011.
- [3] Praveen et al., "Implications of simultaneous mechanical and thermal loads on the rheological properties of the grease in AH-64 helicopter gearboxes", proceedings of the AHS 66th Annual Forum, Phoenix, AZ, May 11-13, 2010.
- [4] Abdel Bayoumi, Amber McKenzie, Kareem Gouda, Jacob McVay and Damian Carr "Impact of Lubrication Analysis on the Improvement of AH-64D Helicopter Component Performance," Proceedings of the AHS 68th Annual Forum, Ft. Worth, TX, May 1-3, 2012.
- [5] Test Plan- AH-64 Testing of SHC 626 Oil in IGB-Developmental-TTS 83442, 3 June 2010.
- [6] "Test article summary report: AH-64 IGB oil based study." USC CBM Center Internal Report, July 2011.

- [7] DMWR 1-1615-302: Depot Maintenance Work Requirement Containing National Maintenance Repair Standards for Tail Rotor Gearbox, US Army Aviation and Missile Command, Redstone Arsenal, AL, 2002.
- [8] Abdel Bayoumi, Nicholas Goodman, Ronak Shah, Trevor Roebuck, Andrew Jarvie, Les Eisner, Lem Grant, Jonathan Keller, "CBM at USC - Part III: Aircraft Components Mapping and Testing for CBM", in Proceedings of the AHS International Specialists' Meeting on Condition Based Maintenance, Huntsville, AL, 2008.
- [9] Stewart, R.M., "Some Useful Data Analysis Techniques for Gearbox Diagnostics," Report MHM/R/10/77, Machine Health Monitoring Group, Institute of Sound and Vibration Research, University of Southampton, July 1977.
- [10] Miller, I., and Freund, J.E., Probability and Statistics for Engineers, 3rd Edition, Prentice-Hall, Inc., Englewood Cliffs, NJ, 1985.
- [11] W. C. De Silva, Vibration Monitoring, Testing, and Instrumentation. CRC Press, 2007.
- [12] Randall, Robert. Vibration-based Condition Monitoring. Singapore: Markono Print Media Pte Ltd, 2011. Print.
- [13] Mobley, R. Keith. An Introduction to Predictive Maintenance. 2nd ed. Amsterdam: Butterworth-Heinemann, 2002. Print.
- [14] Saxena, Abhinav. "Knowledge-Based Architecture for Integrated Condition Based Maintenance of Engineering Systems." : n. pag. Print.
- [15] P. Večeř, M. Kreidl, R. Šmíd, "Condition Indicators for Gearbox Condition Monitoring Systems." *Czech Technical University in Prague* 45: 2005.

- [16] IAC 1209 Modernized Signal Processing Unit. [Online]. www.iac-online.com
- [17] Allen, Jamie. Interview by Travis Edwards.
- [18] Spigner, David. Interview by Travis Edwards
- [19] Chun-Yao Lee, Chen-Chien Kuo, Ryan Liu, I-Hsiang Tseng, Lu-Chen Chang, "Detection of Gearbox lubrication Using PSO-Based WKNN." *Measurement Science Review*, 2013.
- [20] Parikka, Risto, and Aino Helle. "Monitoring of Grease Lubrication."
- [21] Priebe, Gerry "Synchronous Averaging – The Trigger is Everything..." PowerPoint presentation.
- [22] K. M. Gouda, J. A. Tarbuton, Jacob McVay, Abdel Bayoumi. "Nanolubricant Oil Additives for Performance Improvement of the Intermediate Gearbox in the AH-64D Helicopter." Proceedings of AHS 70th Annual Forum, May 20-22, 2014.
- [23] Alex Cao, Joshua Tarbuton, Rhea McCaslin, Erin Ballentine, Lester Eisner, Abdel E. Bayoumi. "Condition-Based Maintenance at the University of South Carolina: A Smart Predictive System." Proceedings of AHS 69th Annual Forum, May 21–23, 2013.
- [24] Mohammed A. Hassan, David Coats, Abdel E. Bayoumi. "Condition Monitoring of Helicopter Drivetrain Components Using Bispectral Analysis." Proceedings of AHS 70th Annual Forum, May 20-22, 2014.
- [25] Travis Edwards, Thomas Hartmann, Andrew Patterson, Samuel Bernstel, Joshua Tarbuton, Abdel Bayoumi, Damian Carr, Lester Eisner. "AH-64D Swashplate Test Stands - Improving Understanding of Component Behavior in Rotorcraft

- Swashplates through External Sensors." AHS Airworthiness, CBM, and HUMS Specialists' Meeting, Feb 2013.
- [26] Abdel Moez E. Bayoumi, Nicholas Goodman, Ronak Shah, Vytautas Blechertas. "Mechanical Diagnosis and Prognosis of Military Aircraft: Integration of Wear, Vibration Time-Frequency Analysis and Temperature into Diagnosis Algorithms." Advanced Materials For Application In Acoustics and Vibration, Cairo, Egypt, Jan 4-6 2009.
- [27] Abdel Bayoumi, Nicholas Goodman, Ronak Shah, Trevor Roebuck, Andrew Jarvie, Les Eisner, Lem Grant, Jonathan Keller. "CBM at USC - Part III: Aircraft Components Mapping and Testing for CBM." Proceedings of AHS International Specialists' Meeting on Condition Based Maintenance, Huntsville, AL, 12-13 Feb 2008.
- [28] Abdel Bayoumi, Nicholas Goodman, Ronak Shah, Les Eisner, Lem Grant, Jonathan Keller. "CBM at USC - Part II: Implementation of CBM through the Application of Data Source Integration." Proceedings of AHS International Specialists' Meeting on Condition Based Maintenance, Huntsville, AL, 12-13 Feb 2008.
- [29] Niknam, Seyed, Victor Songmene, and Y.H. Au. "PROPOSING A NEW ACOUSTIC EMISSION PARAMETER FOR BEARING CONDITION MONITORING IN ROTATING MACHINES." *Transactions of the Canadian Society for Mechanical Engineering* 37.4 (2013): 1105-114. Print.

APPENDIX A – PRE-RUN INSPECTION

Operator 1: _____ Operator 2: _____

Date: _____ Tail Number: _____

PRE RUN

Along with the standard procedures for running the TRDT test stand outlined in the PMD

- Any grease leaks around breather port need to be measured, noted in the log book, cleaned and fixed.
- Ensure the hose around the breather port is firmly connected and free of rotating components.
- IR Camera is pointed at IGB, in focus and the box is around the IGB.
- Variances for the thermocouples should be checked in the test mode selector. If the variances are greater than 10 a note should be made to be fixed as soon as convenient. (Variances over 20 indicate a bad connection and should be fixed immediately)
- The cyclic wheel should be pulled off the plate, the static force set to 0±50 lbs.
- Hydraulics switches turned off for duration of run.
- Increment tail number in GBS and in log book for each gearbox using designation TE-000x. Where x is the gearbox number. For example, the second gearbox used will be TE-0002.

POST RUN

- Any grease leaks around breather port need to be measured, noted in the log book, cleaned and fixed.
- Make sure all data files are accurate by checking GBS and LabVIEW data :
 - o Is it there?
 - o Are there the right number of files there?
 - o Each file the correct size?

If not, alert Travis.

Initials

Operator 1

Operator 2

Inspector 1:

Date:

Inspector 2:

Time:

Drive Motor Checks (Motor Room)

- Drive motor mounting bolts torque striped
- Blower motors and filters unobstructed
- Drive motor to Input Driveshaft bolts torque striped
- Overall room condition satisfactory
- Blower fan switch on

Drive Motor Chiller (Chiller Room)

- Chiller switch in Remote position
- Chiller coolant at proper level
- No major coolant leakage

Motor Control Electrical Cabinet Checks

WARNING!

To prevent death or injury to personnel, ensure main power switch on motor control cabinet is in OFF position prior to opening cabinet doors.

- Main power switch to OFF position
- No evidence of coolant leakage or spilled coolant in cabinet
- No evidence of condensation or moisture in cabinet
- Cabinet electrical connections and wires are secure with no evidence of arcing

WARNING!

Do not attempt to operate Test Stand until any faults found in Drive Motor, Drive Motor Chiller or Motor Control Electrical Cabinet areas have been corrected.

Input Driveshaft Checks

- Universal joints undamaged
- Slip yoke has minimal radial play
- Shaft turns freely without noise
- Input to Isolation Driveshaft bolts torque striped
- Safety loop bolts torque striped
- Input torque transducer mounting nuts torque striped

Isolation Assembly Checks

- Tachometer and interrupter undamaged
- Forward Hub has no axial or radial play
- Forward and Aft Bearing mounting bolts torque striped
- Forward and Aft Bearing set screws torque striped
- Aft Hub has no axial or radial play
- Aft Hub to #3 Driveshaft Flex Coupling bolts torque striped

#3 Driveshaft and Flex Coupling Checks

- Flex Coupling undamaged
- Flex Coupling to Driveshaft bolts torque striped
- Driveshaft has no dents, scratches, or gouges
- Driveshaft to Forward Hanger Bearing bolts torque striped
- Safety loop bolts torque striped

Forward Hanger Bearing Checks

- Thermocouples and accelerometers firmly secured
- Bearing Housing attachment bolts torque striped
- Bearing has no axial or radial play
- Bearing to #4 Driveshaft Flex coupling bolts torque striped

#4 Driveshaft and Flex Couplings Checks

- Forward Flex Coupling undamaged
- Forward Flex Coupling to Driveshaft bolts torque striped
- Driveshaft has no dents, scratches, or gouges
- Anti-flail devices undamaged and firmly secured
- Anti-flail mounting bolts torque striped
- Driveshaft to Aft Flex Coupling bolts torque striped
- Aft Flex Coupling undamaged
- Aft Flex Coupling to Aft Hanger Bearing bolts torque striped
- Safety loops torque striped

Aft Hanger Bearing Checks

- Thermocouples and accelerometers firmly secured
- Bearing Housing attachment bolts torque striped
- Bearing has no axial or radial play
- Bearing to #5 Driveshaft bolts torque striped

#5 Driveshaft and Flex Coupling Checks

- Driveshaft has no dents, scratches, or gouges
- Anti-flail devices undamaged and firmly secured
- Anti-flail mounting bolts torque striped
- Driveshaft to Flex Coupling bolts torque striped
- Flex Coupling undamaged
- Flex Coupling to Intermediate Gearbox bolts torque striped
- Safety loops torque striped

Intermediate Gearbox Checks

- Gearbox mounting nuts torque striped
- Thermocouples and accelerometers firmly secured
- No significant quantity of grease leakage apparent
 - Grease service levels checked
- Output flange to flex coupling bolts torque striped

#6 Driveshaft and Flex Couplings Checks

- Lower Flex Coupling undamaged
- Lower Flex Coupling to Driveshaft bolts torque striped
- Driveshaft has no dents, scratches, or gouges
- Driveshaft to Upper Flex Coupling bolts torque striped
- Upper Flex Coupling undamaged
- Upper Flex Coupling to Tail Rotor Gearbox bolts torque striped

Tail Rotor Gearbox Checks

- Gearbox mounting nuts torque striped
- Thermocouples and accelerometers firmly secured
- No significant quantity of grease leakage apparent
 - Grease service levels checked
- Output spline and Output Adaptor Hub fully flush

Static Cylinder Checks

- Static cylinder is firmly secured
- Static insert nut is firmly secured
- Static cylinder is not leaking

APPENDIX B – EXPANDED RAW VIBRATION RESULTS

TE-001						TE-001						TE-001					
FPG10L1						FPG10L2						FPG10L3					
0%	25%	50%	75%	100%	Diff	0%	25%	50%	75%	100%	Diff	0%	25%	50%	75%	100%	Diff
5683.1	4466.3	4537.1	3119.2	2859.2	2823.9	6890	3363	3730.1	7705.7	1643.2	5246.8	3056.6	3553.8	3334.3	5826.4	3119.5	-62.92
6396.9	5126.2	4541	2159.1	2475.9	3321	4162.2	2511.7	3061	2041.8	1064	3098.2	2678.3	2897.2	1399.9	3720.7	1835.6	842.65
57447	30448	9663.5	7001.8	4893.7	52553	64460	4014.2	6719.6	14633	4701.3	59759	16214	6045.2	2359	5277.1	6204.7	10009
8330	3590.6	3896.2	2267.6	2251.8	6078.3	4870.1	2159.7	2493.8	5171.3	1004.2	3865.9	2665.6	3799.1	1506.6	2988.1	2400.2	265.39
8583.9	6639	2373.4	1900.5	2188.8	6395.1	4224.4	1944.9	2334.2	3572.6	1889.4	2335	2948.2	2761.9	1916.2	3543.2	1922.9	1025.3
9820.7	7685.5	4908.6	4117	2740.8	7073.9	7727.7	3319.7	2040.4	3008.8	1544.7	6183.1	5046	4035.5	2975.2	3504.8	1907.1	3138.9
7678.4	7046.7	5166.2	3799.9	2285.4	5333	7862.5	3677.7	3441.5	10834	947.14	6315.3	4443.9	4633.8	2321.4	3843.6	5651.8	-1208
8919	4414.7	4166.9	2653.1	2803.3	6015.7	2124.9	1707.9	4943.9	3021.4	1513	19736	3261.2	3284.6	2998	3245.2	2490	771.25
10291	1112	1184	4094.4	4189.3	6101.3	9430	8737.4	8423.7	7407.9	1190.9	8239.2	9924.6	12866	4957	4114.1	6609.1	3315.5
8801.4	6030.7	3311.4	2364.3	1969.7	6831.7	5092.1	2176.7	2225.7	2553.6	1350.4	3741.6	3394.3	2395.8	1259.6	3038.4	1366.6	2027.6
22039	14713	10463	6177.4	11437	10602	12240	14264	4638.4	7353.4	10969	12714	12799	10061	3347.1	24963	11695	1103.9
22039	14713	10463	6177.4	11437	10602	12240	14264	4638.4	7353.4	10969	12714	12799	10061	3347.1	24963	11695	1103.9
22039	14713	10463	6177.4	11437	10602	12240	14264	4638.4	7353.4	10969	12714	12799	10061	3347.1	24963	11695	1103.9
7488.4	6965.9	3445.3	2415.3	2762	4726.3	6869.4	2796.8	4276.9	2778.5	1000.1	5869.4	6038.6	5837.1	1954	2514	1780.9	4257.7
7488.4	6965.9	3445.3	2415.3	2762	4726.3	6869.4	2796.8	4276.9	2778.5	1000.1	5869.4	6038.6	5837.1	1954	2514	1780.9	4257.7
5532.1	4413.8	2484.3	1728	2712.1	2880.1	5918.3	1722	3112.1	2752.7	782.3	5136	3078	2708	2634.3	2415.8	3312.1	-234.2
5532.1	4413.8	2484.3	1728	2712.1	2880.1	5918.3	1722	3112.1	2752.7	782.3	5136	3078	2708	2634.3	2415.8	3312.1	-234.2
7654.5	4213.4	2568.1	2092.4	1731.1	5323.4	7408.1	1665	3366.4	2537.4	811.03	6597	3142.4	2234.7	1912.9	1956.4	1711.1	1431.3
6044.7	5839.7	2338.1	2092.8	1704.9	4338.8	5644.9	1990.4	2499.3	1588.8	978.34	4666.6	4526.8	3994.8	1434.1	1623.2	1427.6	3099.2
6176.1	7349	6593.3	2220.3	7407.6	-1232	5867.4	7409.3	8004.1	13915	2348.3	3519.1	3175.6	14892	6340.9	5264.6	3302.8	-127.2
1185	11534	6436.5	13386	12801	-1616	7498.9	6744.9	5104.7	11308	4813.6	2685.3	5175.5	4661.7	5166.1	16456	4439.2	736.37
5678.7	3975.2	2164.9	1501.3	1443.5	4235.2	5077.2	1396.5	2366.7	1957.3	695.55	4381.6	3123.9	2849	1398.1	1607.7	1076.2	2047.7
4216.8	3503.1	2267.3	1957.1	2739.3	1477.5	4341.8	1801.8	2346.2	2620	1119.2	3222.6	3210.3	3177.4	1297.1	2983	1183.1	2027.2
4423	3051.5	2292.5	1431.2	1311.4	3111.6	3759.6	1405	3162	2825	574.87	3184.7	2992.7	2998.8	1386.5	1634.9	1164.6	1828.1
7718.8	3340	3010.2	1767.2	2079.1	5639.8	4567.9	3540.3	3134.2	5111.6	1155.2	3412.7	4411.5	4085.6	2789.9	2299.6	2859.1	1552.4
7718.8	4105.6	3671.7	2071	2119.3	5593.5	3847.1	3949.8	4381.1	5910.5	1499.3	2347.7	4411.5	5250.9	3908	2299.6	2859.1	1552.4
7718.8	4105.6	3671.7	2071	2119.3	5593.5	3847.1	3949.8	4381.1	5910.5	1499.3	2347.7	4411.5	5250.9	3908	2299.6	2859.1	1552.4
2341	2099.1	1784	1328.8	1070.9	1870.2	2921.3	1165.9	1901	1138.9	612.56	2308.8	2910.9	2544.7	867.16	1103.5	853.42	2057.5
3773.3	3997.5	2118.2	1305.1	10700	-6926	2907.8	3619	3835	6041.4	5189.2	-2281	9419.1	4514	3726.3	8117.5	6222	3197.1
2400	1942.4	1501.3	993.66	1398.5	1001.5	2453.7	914.21	1525.4	1090.8	691.97	1761.7	2162.2	2143.8	845.48	1083.2	919.41	1262.8
3825.7	2806.8	2097.4	2313.1	3931	-105.4	2630.6	1300.1	2089.9	2197.6	2075.9	554.71	1843.5	1736.5	1484.3	9408.1	1510.4	333.08
2406.2	1276.4	2044.2	826.32	1726.3	679.87	1960.8	953.85	1443.9	999.93	976.82	983.95	1737.6	1546.8	1857.1	1411.6	1549.2	188.35
2530.4	2278.4	2035.4	901.42	4943	-2353	2750.7	1726.1	3121.9	1591.9	1590.6	1160.1	2015.4	1690.6	3374.7	3297	538.86	2173.5
1794.4	1282.4	1573.5	685.32	1152.5	611.9	1851	648.67	1372.3	674.62	441.97	1409	1257.8	1253.5	785.32	808.33	600.48	657.32
1851.9	1521.1	2653.4	822.5	1041.4	840.49	1904.1	1027	1372.3	674.62	681.65	1222.5	2051.3	1308.3	1053.3	1059.2	1140.9	910.36
1971.9	1421.5	8560.4	761.84	1266.2	705.73	1646.8	1471.7	1107.3	746.87	851.37	795.44	1637.8	1255.1	1673.6	1594.7	956.98	680.87
2283.1	1421.5	8560.4	761.84	1266.2	1017	1718.6	1471.7	1107.3	746.87	851.37	867.27	1637.8	1255.1	1673.6	1594.7	956.98	680.87
1574.2	1062.8	1702.1	498.16	1366.8	187.37	1546.2	675.56	948.97	645.5	820.79	725.45	972.35	1046.8	2020.9	1041.8	470.93	501.42
1484.3	972.89	1169.8	664.94	809.18	675.11	1335	910.7	1086	579.33	820.15	514.85	862.07	903.16	881.66	886.41	727.76	134.31
1484.3	972.89	1169.8	664.94	809.18	675.11	1335	910.7	1086	579.33	820.15	514.85	862.07	903.16	881.66	886.41	727.76	134.31
1346.3	894.66	951.64	433.22	809.18	537.13	1335	486.55	944.7	579.33	311.26	1023.7	744.74	994.1	558.72	582.65	433.51	311.26
1346.3	894.66	951.64	433.22	809.18	537.13	1335	486.55	944.7	579.33	311.26	1023.7	744.74	994.1	558.72	582.65	433.51	311.26
1413.3	926.05	972.82	570.01	2175.5	-762.2	1383.8	830.98	838.6	609.79	953.11	430.69	892.52	877.04	718.54	696.98	556.29	336.23
1413.3	926.05	972.82	570.01	2175.5	-762.2	1383.8	830.98	838.6	609.79	953.11	430.69	892.52	877.04	718.54	696.98	556.29	336.23
1405.2	1410.2	1325	1001.3	2911.2	-1506	1111.2	1273.9	926.03	775.19	322.71	788.47	809.58	1308.5	652.01	1438.2	1012.9	-203.4
1073.7	763.58	663.92	545.96	696.88	304.41	946.71	462.35	659.77	448.2	702	244.72	662.45	646.02	662.92	732.36	925.34	-262.9
1073.7	763.58	663.92	545.96	696.88	304.41	946.71	462.35	659.77	448.2	702	244.72	662.45	646.02	662.92	732.36	925.34	-262.9
1073.7	763.58	663.92	545.96	696.88	304.41	946.71	462.35	659.77	448.2	702	244.72	662.45	646.02	662.92	732.36	925.34	-262.9
1267	1259.9	1006.1	940.37	1170.9	96.129	984.91	1183.1	614.46	1652.6	1444.3	-459.4	2541.9	642.13	463.61	1708.5	1934.1	607.83
1267	1259.9	1006.1	940.37	1170.9	96.129	984.91	1183.1	614.46	1652.6	1444.3	-459.4	2541.9	642.13	463.61	1708.5	1934.1	607.83
1011.3	823.43	644.94	354.2	573.54	431.78	845.44	433.79	556.63	433.26	410.57	434.87	684.62	540.99	600.46	466.24	457.5	227.12
979.41	681.65	1421.7	409.17	1088.5	-109.1	822.3	550.2	554.55	1073.8	835.98	-13.68	1271.3	641.62	568.29	696.46	1234.2	37.072
979.41	681.65	1421.7	409.17	1088.5	-109.1	822.3	550.2	554.55	1073.8	835.98	-13.68	1271.3	641.62	568.29	696.46	1234.2	37.072
890.33	613.12	639.69	458.22	626.71	263.62	698.94	360.14	483.58	460.38	359.31	339.63	521.38	595.66	321.96	680.5	842.99	-321.6
873.38	688.73	643.23	346.09	400.15	473.24	647.09	345.36	512.58	371.77	216.21	430.88	545.48	493.83	332.68	381.03	310.5	234.96
865.63	455.88	589.23	281.12	334.16	531.48	649.64	264.54	432.14	454.08	239.62	410.02	518.93	401.2	377.92	329.15	364.49	154.44
765.43	510.71	539.84	273.97	334.4	431.03	605.04	267.59	439.96	308.59	212.07	332.97	467.05	418.83	393.9	333.89	300.45	166.6
694.05	480.55	539.84	278.86	309.97	384.07	605.04	255.49	459.66	307.89	187.47	417.57	467.05	389.61	326.06	333.89	256.36	210.69
681.99	640.81	679.67	458.26	420.56	261.42	580.74	263.36	443.9	292.5	259.04	321.69	424.83	483.82	456.41	346.84	819.96	-395.1
733.41	640.81	679.67	458.26	420.56	261.42	580.74	263.36	443.9	292.5	259.04	321.69	424.83	483.82	456.41	346.84	819.96	-395.1
742.38	644.35	521.39	330.09	408.2	334.18	536.39	323.1	398.13	277.23	292.97	243.42	47					

TE-002						TE-002						TE-002					
FPG10L1						FPG10L2						FPG10L3					
0%	25%	50%	75%	100%	Diff	0%	25%	50%	75%	100%	Diff	0%	25%	50%	75%	100%	Diff
8219.9	6841.9	6366.4	6086.3	7535.5	684.34	8887.4	7257.9	8015	5393.7	8765.5	121.93	7901.3	7474.1	8264.4	6960.2	8663.9	-762.5
417.05	680.85	1175.7	593.5	774.71	-357.7	663.5	517.36	551.51	528.18	498.8	164.7	883.63	385.02	445.58	411.78	594.2	289.43
3243.7	2017.2	5535.4	2797.3	7780	-4536	1884.9	2297.8	6607.9	3152.2	12192	-10307	2019.6	1846.9	3057.1	2002.9	10738	-8718
1711.6	2109.3	1632.1	1642.6	1982	-270.4	2008.4	1709.8	2285	1534.3	1916.2	32.248	1949	1968.7	1879.5	1520.7	2041.4	-32.4
2851.6	3096	2489.7	2553.7	2937.8	-86.24	2586.3	3644.7	3276.7	2656.8	3027.2	-441	2689.3	3029.6	2788.9	2080.7	3160.7	-471.4
3208.2	3475.1	2775.5	2727	3261	-52.78	3412	3069.2	3576	2716.7	3366.5	45.446	3268.2	3240.5	3334.3	2745.4	3468.5	-200.2
7857.8	5645.2	4870.8	5938.6	5940.2	1917.6	7185.8	5458.3	7202.5	5759.8	7880.4	-694.7	6385.5	5683.2	6493.8	5862.7	7818.8	-1433
6064.4	6599.2	5065.8	5679.4	5791.8	272.53	7701	8288	9628.1	5507	6815.6	885.47	6955.4	6147.9	6179	6006.1	6962.6	-7.263
50974	46844	23561	47081	37791	13183	49545	41886	42756	46046	37044	12501	37584	42964	54433	55877	37828	-244.1
19794	18431	14451	16326	19743	51.131	18022	15397	21641	13831	21211	-3189	16502	16700	18728	15731	20675	-4173
182495	158634	135913	154241	175722	6772.6	167918	153898	190906	127501	193135	-25216	160612	156119	171154	147175	183128	-22515
182495	158634	135913	154241	175722	6772.6	167918	153898	190906	127501	193135	-25216	160612	156119	171154	147175	183128	-22515
182495	158634	135913	154241	175722	6772.6	167918	153898	190906	127501	193135	-25216	160612	156119	171154	147175	183128	-22515
4918.4	4373.5	8006.5	3827.3	6773.6	-1855	4314.3	4067.7	4298.9	3529.3	5211.4	-897.1	3757.8	4829	4384.7	3727	4672.8	-915
7153.4	4555.5	10902	4108.8	11067	-3913	3233.5	5669.8	4106.9	3337.5	7390.2	-4157	3349	4075.4	4384.7	3717.1	5518.4	-2169
6957.1	6540.1	7692.3	4144.2	8581.3	-1624	9092.6	8979	7083.7	9138.5	8628.7	463.9	8308.8	8635.1	9309	10048	5727.6	2581.2
6957.1	6540.1	7692.3	4144.2	8581.3	-1624	9092.6	8979	7083.7	9138.5	8628.7	463.9	8308.8	8635.1	9309	10048	5727.6	2581.2
30998	38820	32127	33347	39016	-8018	19029	51583	36285	35391	40053	-21023	28275	48520	38108	34526	37359	-3085
2365.6	1511.1	1608.4	1643	1867.3	498.32	1562.1	2133.3	1876.6	1603	2523.4	-961.2	1226.9	1840.5	2212.1	1223.9	1656	-423.2
14946	19916	13481	6499.8	15602	-656.5	18221	27000	16206	7443.3	19461	-1241	17445	28109	8228.2	7080.1	18333	-887.5
87635	101669	32092	103245	100107	-12472	78764	100937	55791	125496	69232	9532	81710	111091	105565	79660	82876	-1166
2784.4	2899.2	2445.9	1755.4	2196	588.44	2999.4	2404.2	3157	2571.9	3013.8	-14.37	2290.7	2168.4	2592.8	2491.6	3486	-1195
17500	18038	12836	11368	10103	7396.3	15145	14508	8788.9	9971.9	10694	4451.3	12283	15531	11264	8809.8	13407	-1124
4454.4	2384.8	1830.7	1371.5	4975.5	-521.1	4420.1	2394.2	2930.8	2688.2	3166.1	1254.1	3622.3	2294.7	1892	1832.2	2057.1	1765.2
43116	21734	15081	12309	44212	-1096	36013	9634.8	24403	22118	19122	16891	37487	8564.1	13608	12100	13284	24203
43116	25731	15081	13784	49586	-6470	41642	13545	24403	22973	25331	16311	37487	12321	13939	13834	16846	20641
43116	25731	15081	13784	49586	-6470	41642	13545	24403	22973	25331	16311	37487	12321	13939	13834	16846	20641
6055	3277.5	3416	2954.1	3977.9	2077.1	3368.6	2478.5	2736.1	3059.2	1971.3	1397.2	2724.7	2021.7	2282.6	2054	3826.8	-1102
36824	11029	29635	32804	32197	4627.4	20031	30879	55868	33147	44606	-24374	7381.5	31816	12476	21217	35344	-27963
1905.3	1589.3	1523.3	1342.5	2424.8	-519.6	1258.3	3598	2101.8	1799.4	2912.3	-1654	2638.3	2668.9	2010.6	1282.5	2541.4	96.898
6721.8	16944	15970	19713	25089	-18368	16990	5759.8	30188	12238	20721	-1730	13155	6017.6	23994	25920	17689	-4533
23102	16782	18349	7454.9	7333.8	15768	17120	22965	16338	7309.7	5727.1	11483	14181	13398	7144.2	3853.4	7783.2	6397.9
46216	18012	70165	22844	52120	-5904	40541	36286	68054	31741	46840	-6239	19409	20892	47301	25964	48009	-28599
21078	16459	20776	13479	9880.5	11198	25668	17803	17734	14163	13768	16300	16911	12600	15517	16650	13697	3213.2
2722.4	2112.4	4098.6	2737.6	3277.8	-555.4	2239.9	2847.9	5886.4	3920.1	3454.5	-1215	2626.8	4659.4	3091.7	3572.8	4411.8	-1785
11068	20108	15225	20843	24835	-13767	5631.9	20023	35382	25489	27494	-21862	32451	14840	17311	12136	25620	6831.1
11068	20108	15225	20843	24835	-13767	5631.9	20023	35382	25489	27494	-20630	32451	14840	17311	12136	25620	6831.1
25351	16662	9923.6	14506	16192	9159	15646	13650	13748	8004.8	21251	-5805	11603	13902	10190	8359.7	22772	-1169
24935	17531	24827	11758	18334	6601.5	9625.2	20817	8175.5	7582.3	11980	-2354	3140.6	15574	8410.4	7211.2	14391	-5250
12425	1640	9849.5	6160.8	8029.6	4395.6	9625.2	16229	4490.5	5387.1	7709.1	1916.2	9140.6	1519	8410.4	7211.2	12423	-3283
12425	10876	8449.2	8220	11027	1398	9353.6	10299	7708.1	7593.7	8918.7	434.97	9750.3	7495.4	7587.1	7211.2	10835	-1085
42173	64588	60058	75526	80364	-38191	23239	51877	60375	68478	62426	-39187	64489	50453	51336	28891	71395	-6906
50115	43759	44559	43135	37608	12507	52408	60906	23992	41074	32032	20376	38832	51180	43685	22629	48095	-3263
50115	42313	44559	43135	37608	12507	52408	38997	23992	41074	32032	20376	38832	40244	43685	22629	48095	-3263
3E+06	1E+06	716995	863417	1E+06	125670	1E+06	935265	759657	857270	1E+06	34031	1E+06	993113	1E+06	507508	1E+06	85018
12271	23890	29445	21899	15388	16883	27229	38203	24602	15856	21662	5567.6	21559	43708	19826	1144	22708	-1148
32271	14809	29445	21899	15388	16883	22894	15840	24602	15211	21662	1232.5	16635	25991	19826	1144	22708	-6072
16658	11524	20864	13541	15046	1612.2	17921	15840	15952	10567	17818	102.61	12272	25991	14441	7404.5	13203	-9314
190193	139433	140413	139508	149925	40268	170112	133879	170867	100813	153744	16368	157456	140989	149895	54699	144895	12561
190193	139433	140413	139508	149925	40268	170112	133879	170867	100813	153744	16368	157456	140989	149895	54699	144895	12561
15104	14902	13095	15887	8958.2	6145.8	9072	16524	13859	10812	15873	-6801	12849	16193	11934	9488.6	15214	-2385
24628	37968	38106	31625	41557	-16930	21974	25861	40137	22084	34855	-12881	29657	25275	34500	11334	33372	-3715
24628	37968	38106	31625	41557	-16930	21974	25861	40137	22084	34855	-12881	29657	25275	34500	11334	33372	-3715
73722	85458	50887	67597	49744	23978	84185	90825	108730	54545	105811	-21627	49997	45316	23649	22619	19194	-41907
63066	31871	43046	47980	41652	21414	33917	38330	65639	39330	29137	4780.2	46484	33374	35481	23134	12585	33898
22753	17989	23573	16227	15231	7522.6	19323	28872	11028	10658	28142	-8819	29507	25538	16728	11665	23310	6196.5
27281	25890	31376	14097	23289	3992.1	30403	20576	16460	23390	18803	11600	19768	16273	25825	23567	19324	444.18
58966	22950	55478	65107	48132	10834	34158	33887	74327	54965	48665	-14507	54154	39857	63703	34735	97619	-43465
58966	22950	55478	65107	48132	10834	34158	33887	74327	54965	48665	-14507	54154	39857	63703	34735	97619	-43465
9157.6	29256	26269	31534	32198	-23040	19495	64629	45571	34150	51949	-32454	39484	60075	49550	38277	89294	-49810
9074.6	29256	26269	31534	32198	-23123	19495	64629	45571	34150	51949	-32454	39484	60075	49550	38277	89294	-49810
20606	74438	45626	34506	32426	-11819	23108	32621	25761	113945	32187	-9079	68597	43266	60899	41857	49335	18662
21730	142903	38966	30910	25057	-3327	22069	73815	28338	45432	12108	860.49	106827	97809	32830	21400	25450	81377
23765	71013	40699	44134	65468	-41703	38868	36409	26275	69200	625							

TE-003						TE-003						TE-003					
FPG10L1						FPG10L2						FPG10L3					
0%	25%	50%	75%	100%	Diff	0%	25%	50%	75%	100%	Diff	0%	25%	50%	75%	100%	Diff
398	339	705	1157	390	8	782	1166	561	835	893	-111	633	811	873	928	645	-12
161	73	206	102	157	5	159	161	177	108	219	-60	237	192	311	169	249	-12
314	137	303	500	565	-250	512	597	379	342	455	56	318	287	439	335	355	-37
99	144	166	210	211	-112	204	234	309	169	263	-59	240	304	224	251	305	-65
245	132	653	251	513	-268	378	788	921	247	846	-467	283	880	477	736	405	-122
331	227	317	631	316	15	922	497	498	285	424	438	644	311	372	422	393	251
591	350	511	613	459	132	305	675	477	277	364	-58	383	665	380	388	440	-57
231	333	350	819	290	-59	350	445	323	486	300	50	374	597	309	644	414	-40
1479	2715	1519	4605	1090	389	2947	5141	3439	4009	3009	-61	2384	3994	2323	5147	2295	89
201	161	315	344	291	-90	333	424	365	274	357	-24	322	323	404	457	354	-32
244.14	632.22	399.71	1056.7	445.4	-201.3	429.71	763	647.17	557.56	658.92	-229.2	485.51	761.47	296.63	474.71	877.99	-392.5
244.14	632.22	399.71	1056.7	445.4	-201.3	429.71	763	647.17	557.56	658.92	-229.2	485.51	761.47	296.63	474.71	877.99	-392.5
244.14	632.22	399.71	1056.7	445.4	-201.3	429.71	763	647.17	557.56	658.92	-229.2	485.51	761.47	296.63	474.71	877.99	-392.5
593.42	504.95	1124.4	735.8	893.07	-299.6	1391.2	564.04	683.99	801.25	1327.9	63.328	608.47	664.86	838.13	581.74	795.55	-187.1
593.42	504.95	1124.4	735.8	893.07	-299.6	1391.2	564.04	683.99	801.25	1327.9	63.328	608.47	664.86	838.13	581.74	795.55	-187.1
187.54	379.39	345.9	366.87	316.99	-129.5	297.92	345.77	409.75	287.97	361.18	-63.26	338.53	240.86	609.86	279.41	416.81	-78.29
187.54	379.39	345.9	366.87	316.99	-129.5	297.92	345.77	409.75	287.97	361.18	-63.26	338.53	240.86	609.86	279.41	416.81	-78.29
195.47	182.03	317.85	331.94	269.49	-74.02	330.55	381.3	453.29	166.23	313.48	17.071	372.54	331.98	378.24	272.23	416.52	-43.98
249.22	186.44	512.51	443.7	360.59	-111.4	350.97	488.34	624.39	276.23	477	-126	498.45	460.45	576.73	520.26	931.1	-432.6
67.77	803.06	1047.1	1391.9	1177.6	-500.3	1381.3	777.3	1400	1025.6	1759.1	-377.8	846.37	992.28	2811.4	1955.2	1596	-749.6
276.95	222.14	342.65	423.65	237.22	-20.27	339.72	339.66	428.51	195.66	280.55	59.169	535.79	346.74	422.88	256.54	449.37	86.416
404.51	237.3	383.9	464.98	393.98	10.535	373.31	337.52	571.05	306.78	289.52	83.791	523.21	357.28	452.57	327.6	549.51	-26.31
287.4	159.18	407.78	431.37	285.39	2.0058	399.34	359.93	396.15	193.23	341.85	57.485	400.56	318.96	391.34	256.88	637.75	-237.2
245.63	206.46	499.89	530.34	528.85	-283.2	302.63	599.23	732.32	566.96	411.91	-109.3	436.01	510.71	1154.2	1000.6	590.71	-154.7
216.11	218.01	305.83	356.43	276.98	-60.87	506.59	301.87	458.22	215.36	278.11	228.48	616.54	565.91	351.09	255.09	418.88	197.66
278.01	219.64	470.26	721.26	276.98	1.0395	506.59	438.97	554.19	255.44	399.41	107.18	616.54	623.44	834.64	295.7	643.84	-27.3
278.01	219.64	470.26	721.26	276.98	1.0395	506.59	438.97	554.19	255.44	399.41	107.18	616.54	623.44	834.64	295.7	643.84	-27.3
198.58	148.19	258.87	373.72	257.94	-59.37	335.51	312.61	398.83	209.92	298.21	37.304	402.7	318.25	336.67	244.54	342.3	60.399
235.01	256.59	277.15	499.96	257.94	-22.33	379.78	283.76	498.8	240.85	298.21	81.569	413.84	386.34	396.06	326.33	402.96	10.882
232.96	180.86	281.01	378.15	388.51	-155.6	293.32	343.67	352.2	282.05	290.86	2.4577	334.47	258.77	382.71	365.03	387.46	-52.99
173.31	181.46	271.17	759.54	264.09	-90.78	380.45	357.45	340.35	198.9	251.64	128.81	300.58	313.33	329.74	246.39	330.49	20.089
179.88	141.88	220.14	401.81	243.12	-63.24	254.52	294.09	422.89	154.64	375.89	-121.4	274.75	296.28	438.49	219.78	317.42	-42.67
155.03	114.67	392.14	294.14	234.84	-79.82	256.77	597.78	393.99	184.53	295.69	-38.92	276.91	732.92	519.3	210.84	293.35	-16.44
173.43	115.67	251.32	289.46	243.26	-75.83	262.09	296.1	286.35	241.61	321.43	-59.34	361.18	279.62	273.13	302.59	342.68	38.492
161.41	250.49	318.59	395.87	333.82	-172.4	268.75	296.1	554.35	230.26	325.5	-56.75	259.04	767.23	784.97	238.02	377.29	-118.2
360.8	433.6	662.73	872.58	456.54	-95.74	293.54	653.34	1209.9	292.86	948.08	-654.5	556.97	1118.3	1757.6	387	1270.9	-713.9
360.8	433.6	662.73	872.58	456.54	-95.74	293.54	653.34	1209.9	292.86	948.08	-654.5	556.97	1118.3	1757.6	387	1270.9	-713.9
203.22	218.08	196.31	398.95	224.54	-21.32	221.47	336.52	335.03	186.49	389.25	-167.8	304.32	258.47	411.43	211.62	247.95	56.374
136.13	103.74	210.59	334.88	203.17	-67.03	219.82	227.27	241.29	130.31	198.93	20.899	227.67	192.16	230.7	164.82	247.76	-20.09
134.48	88.572	216.25	237.8	203.17	-68.69	219.82	270.95	257.07	121.03	198.93	20.899	227.67	194.41	228.82	164.82	215.63	12.046
117.42	92.097	216.25	237.8	178.14	-60.72	219.82	270.95	257.07	121.78	198.93	20.899	208.57	198.67	228.82	156.47	215.63	-7.054
116.9	102.46	216.25	245.35	170.84	-53.94	219.82	270.95	261.96	125.75	193.06	26.761	215.09	198.67	260.49	143.94	212.59	2.495
143.19	97.97	180.32	231.34	212.89	-69.7	224.15	236.19	239.77	127.26	180.97	43.185	246.72	263.6	212.23	197.28	217.95	28.772
133.17	128.48	205.36	231.34	212.89	-79.72	208.1	236.19	270.25	127.26	173.76	34.335	246.72	263.6	205.88	197.28	217.95	28.772
428.45	439.56	408.85	418.96	256.79	171.66	747.78	418.69	329.18	277.91	236.47	51.31	811.25	568.8	360.65	244.55	213.19	598.05
114.9	102.53	171.68	244.46	154.23	-39.32	258.6	175.8	208.95	119.85	159.72	98.873	165.91	243.15	252.29	132.16	171.42	-5.516
117.55	102.53	171.68	244.46	154.23	-36.68	258.6	196.49	216.97	113.87	156.89	101.7	171.6	243.15	252.29	132.16	193.14	-21.54
118.5	82.609	171.68	244.46	154.23	-35.72	258.6	196.49	216.97	113.87	156.89	101.7	174.95	177.01	252.29	130.23	214.28	-39.33
118.5	78.678	161.28	180.49	164.61	-46.1	197.1	196.49	216.97	132.39	156.89	40.203	174.95	177.01	174.87	116.22	214.28	-39.33
118.5	78.678	161.28	180.49	164.61	-46.1	214.72	193.69	208.99	132.39	167.64	47.079	174.95	162.98	178.18	126.13	196.77	-21.82
123.04	72.899	150.38	196.22	151.75	-28.7	169.8	196.98	192.07	101.94	158.31	11.488	176.95	151.97	186.39	136.82	202.81	-25.86
118.07	67.501	135.72	175.58	150.24	-32.17	178.44	148.16	184.06	94.572	164.87	13.574	183.88	149.54	169.41	121.65	170.93	12.96
122.92	67.501	163.1	175.58	150.24	-27.32	178.44	171.37	193.24	94.493	134.53	43.909	183.88	149.54	166.69	134.44	170.93	12.96
108.61	69.843	142.03	174.84	126.48	-17.87	167.74	165.97	192.3	99.072	139.28	28.462	172.59	136.29	148.38	105.86	174.38	-1.785
96.203	75.475	137.59	162.21	119.17	-22.96	148.62	179.78	200.58	84.629	142.18	6.4385	145.89	139.66	187.67	121.37	186.91	-41.02
132.35	101.43	203.06	142.44	155.16	-22.81	146.11	191.4	212.67	80.602	220.06	-73.95	199.68	150.93	225.46	126.2	155.86	43.803
93.711	57.9	126.12	153.11	107.19	-13.47	139.95	133.44	189.29	88.503	126.47	13.478	156.23	137.45	146.36	104.02	172.57	-16.34
90.84	57.9	124.36	153.11	100.83	-10.19	139.95	133.44	189.29	95.936	120.07	19.862	156.23	129.69	151.11	104.02	172.57	-16.34
89.546	67.108	125.11	136.12	108.7	-19.16	141.18	142.49	197.45	119.02	108.26	32.912	139.45	188.88	140.86	109.73	144.12	-4.67
80.628	67.108	119.98	125.13	109.89	-29.26	141.18	142.49	169.02	119.02	108.26	32.912	139.45	188.88	136.65	109.73	144.12	-4.67
89.388	62.796	122.71	139.55	94.471	-5.083	121.39	132.54	153.85	76.233	120.25	1.1393	142.44	128.81	154.8	99.518	121.31	21.13
86.332	60.23	117.31	117.25	88.089	0.2433	121.39	132.54	153.85	76.233	106.39	15.005	127.65	128.81	154.8	105.05	121.31	6.3361
86.317	57.971	102.77	132.36	91.428	-5.111	136.67	126.39	137.64	76.507	100.5	36.178	133.35	134.32	117.58	81.549	123.7	9.6484
90.171	52.812	118.71	130.66	85													